

InteliGen^{NT}, InteliSys^{NT}®

Operator Guide

IG-NT, IG-NTC, IG-NT-BB, IG-NTC-BB, IS-NT-BB, IS-NTC-BB,
IM-NT, IM-NT-BB, IM-NTC-BB



ComAp is a member of AMPS (The Association of Manufacturers of Power generating Systems).



ComAp products meet the highest standards, with every stage of production undertaken in accordance with the ISO certification obtained in 1998.

Table of Contents

Table of Contents	2
General guidelines.....	3
Description of the controller system	3
Conformity declaration	3
!! Warnings !!	3
Dangerous voltage	4
Adjust set points	4
Adjust set points	4
Available related documentation	5
InteliVision 5	6
Page Structure	8
Connection	9
Alarms	9
Setpoint Change.....	11
Entering the Password	12
History	17
Display Contrast Adjustment.....	17
Controller Information Screen	18
InteliVision 8	19
Page Structure	24
Connection	25
Alarms	26
Setpoint Change.....	28
Entering the password	31
History	32
Display Contrast Adjustment.....	33
Controller Information Screen	35
InteliGen ^{NT} GC and InteliSys ^{NT}	36
InteliGenNTGC pushbuttons and LEDs	36
InteliSysNT Basebox pushbuttons and LEDs	38
Description of InteliGen ^{NT} MEASUREMENT screens.....	44
Description of InteliSys ^{NT} MEASUREMENT screens.....	47
Users and Passwords	53
Mode and function description.....	54
OFF mode	54
MAN mode	54
AUT mode	54
TEST mode (SPtM only)	55
SEM mode.....	55
List of abbreviations.....	57

General guidelines

This manual provides general information on how to operate the IG/IS-NT controller via IntelliVision 5, IntelliVision 8, IS-Display or from the front panel of IntelliGen^{NT} GC or IntelliMains^{NT} GC. ***This manual is intended for everybody who is concerned with operation and maintenance of the gen-set.***

Description of the controller system

NT family controllers are comprehensive AMF-controllers for single and multiple generating sets operating in stand-by or parallel modes. Synchronizer, isochronous load sharer, Mains and Generator protections allow for a total integrated solution for gen-sets in stand-by and parallel modes with multiple engine support.

NT family controllers (IG-NT, IG-NTC, IG-NT-BB, IG-NTC-BB, IS-NT-BB, IS-NTC-BB, IM-NT, IM-NT-BB and IM-NTC-BB) could be equipped with a powerful colour display showing icons, symbols and bar-graphs for intuitive operation, which sets, together with high functionality, new standards in gen-set controls.

The controller automatically starts the gen-set, closes the gen-set C.B. when all conditions are met, then stops the engine on external signal or by pressing push buttons.

Parallel to Mains operation can be achieved without additional HW. Forward and reverse synchronizing, Mains protection including vector shift, load and power factor control, earth fault protection are the major functions provided. Interfacing to foreign synchronizers and load sharers is supported.

The key feature of NT family controllers is their easy-to-use installation and operation. Predefined configurations for typical applications are available as well as user-defined configurations for special applications.

Conformity declaration



Following described machine complies with the appropriate basic safety and health requirement of the EC Low Voltage Directive 2006/95/EC and EC Electromagnetic Compatibility Directive 2004/108/EEC based on its design and type, as brought into circulation by us.

Note:

ComAp believes that all information provided herein is correct and reliable and reserves the right to update at any time. ComAp does not assume any responsibility for its use unless otherwise expressly undertaken.

!! Warnings !!

Be aware that the binary outputs can change state during and after software reprogramming (before the controller is used again ensure that the proper configuration and setpoint settings are set in the controller)!!!

Be aware that gen-set can automatically or remotely start when following controller terminals are disconnected !!!

- Mains voltage measuring and / or
- Binary outputs for MCB control and / or
- MCB feedback

Switch IntelliGen^{NT} to OFF mode and disconnect the Binary outputs Starter and Fuel to avoid unexpected automatic start of gen-set and GCB closing.

!!! CAUTION !!!

Dangerous voltage

In no case touch the terminals for voltage and current measurement!
Always properly connect grounding terminals!

Take care when disconnecting In/Im3 terminals when the gen-set is stopped.
For safety connect parallel to controller In/Im3 terminals two anti parallel diodes 10A/100V.

In any case do not disconnect generator CT terminals when the gen-set is loaded.

Adjust set points

All setpoints are preadjusted to their typical values. But the setpoints in the “**Basic settings**” settings group **!!must!!** be adjusted before the first startup of the gen-set.

**!!! WRONG ADJUSTMENT OF BASIC PARAMETERS
CAN DESTROY THE GEN-SET !!!**

Available related documentation

PDF files	Description
IGS-NT-SPTM-3.0 Reference Guide.pdf	General description of SPTM applications for IntelliGen NT and IntelliSys NT. Contains description of engine and generator control, control of power in parallel to mains operation, list of all Setpoints, Values, Logical Binary Inputs and Logical Binary Output.
IGS-NT-SPI-3.0 Reference Guide.pdf	General description of SPI applications for IntelliGen NT and IntelliSys NT. Contains description of engine and generator control, control of power in parallel to mains operation, list of all Setpoints, Values, Logical Binary Inputs and Logical Binary Output.
IGS-NT-MINT-3.0 Reference Guide.pdf	General description of MINT applications for IntelliGen NT and IntelliSys NT. Contains description of engine and generator control, powermanagement, list of all Setpoints, Values, Logical Binary Inputs and Logical Binary Output.
IGS-NT-Combi-3.0 Reference Guide.pdf	General description of Combi applications for IntelliGen NT and IntelliSys NT. Contains description of engine, and generator control in SPTM, SPI and MINT mode, powermanagement, list of all Setpoints, Values, Logical Binary Inputs and Logical Binary Output.
IGS-NT-COX-3.0 Reference Guide.pdf	General description of COX applications for IntelliGen NT and IntelliSys NT. Contains description of engine and generator control, powermanagement, list of all Setpoints, Values, Logical Binary Inputs and Logical Binary Output.
IGS-NT Application Guide 05-2013.pdf	Applications of IntelliGen NT, IntelliSys NT and IntelliMains NT, examples of connection, description of PLC functions, Virtual and Shared peripheries.
IGS-NT Operator Guide 05-2013.pdf	Operator Guide for all hardware variation of IntelliGen NT and IntelliSys NT, IntelliVision 5 and IntelliVision 8.
IGS-NT Installation Guide 05-2013.pdf	Thorough description of installation and technical information about IntelliGen NT, IntelliSys NT and IntelliMains NT and related accessories.
IGS-NT Communication Guide 05-2013.pdf	Thorough description of connectivity and communication for IntelliGen NT, IntelliSys NT and IntelliMains NT and related accessories.
IGS-NT Troubleshooting Guide 05-2013.pdf	How to solve most common troubles with IntelliGen NT and IntelliSys NT controllers. Including the list of alarm messages.
IGS-NT & ID-DCU Accessory Modules 05-2013.pdf	Thorough description of accessory modules for IGS-NT family, technical data, information about installation of the modules, how to connect them to controller and set them properly.



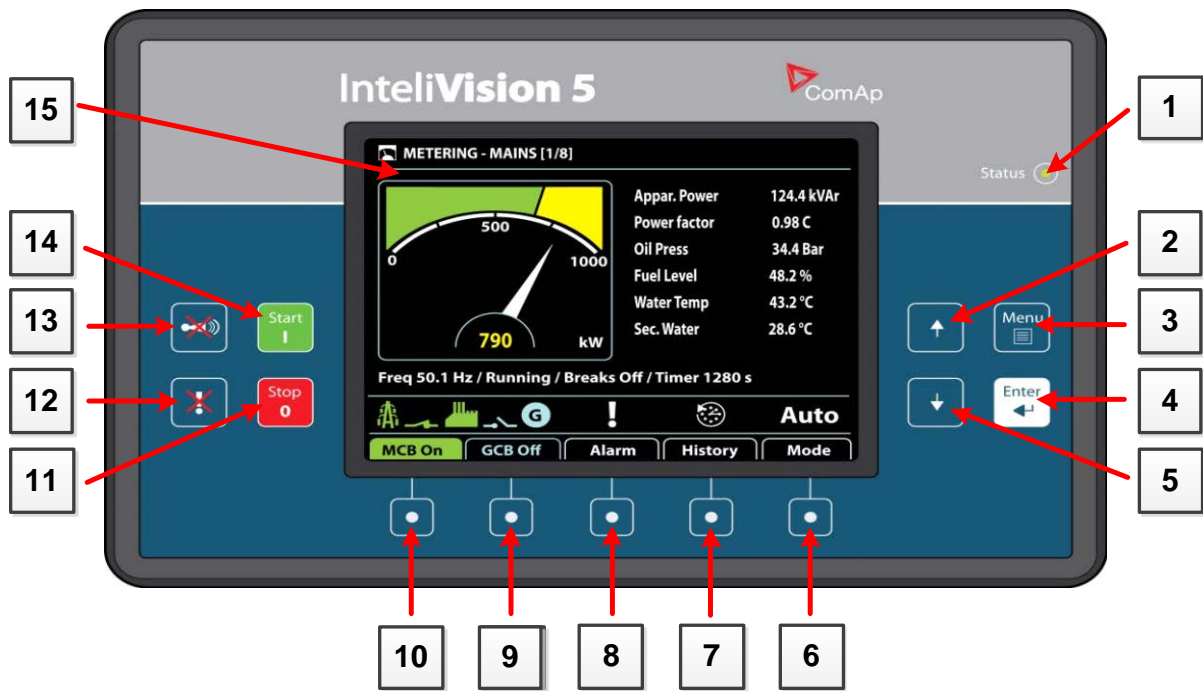

InteliVision 5



INTELIVISION 5 INDICATION

POSITION	DESCRIPTION
1	Status LED indication. The IntelliVision 5 is running.

DISPLAY AND CONTROL BUTTONS

POSITION	BUTTON	DESCRIPTION
2		Up button. Use this button to move up, scroll up the screens or increase a value.
3		Menu button. Use this button to switch to menu subpages. See Pages Structure chapter below this table for more details.
4		Enter button. Use this button to enter item from the list, menu, or confirm a value.
5		Down button. Use this button to move down, scroll down the screens or decrease a value.

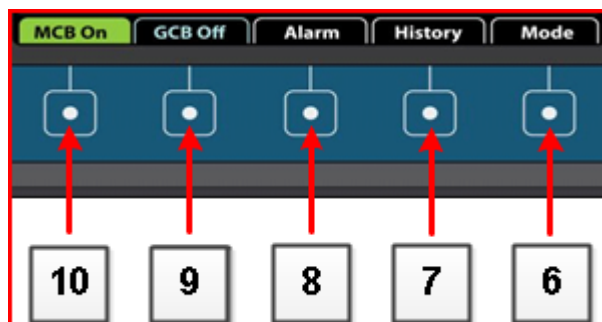





CONTEXT SENSITIVE BUTTONS

POSITION	INDICATOR DESCRIPTION
6	Mode button. Use this button to call mode change.*
7	History button. Use this button to call controller history screen.*
8	Alarm list button. Use this button to enter Alarm list.*
9	GCB button. Works in MAN mode only. Press this button to open or close the GCB manually. Note that certain conditions must be valid otherwise GCB closing is blocked.*
10	MCB button. Works in MAN mode only. Press this button to open or close the MCB manually.* CAUTION! You can disconnect the load from the mains supply with this button! Be sure you know well what you are about to do!

* - It is valid in default configuration only. Screens description and buttons 6 to 10 could have different meaning in customized versions or SW branches.

GEN-SET CONTROL BUTTONS AND DISPLAY

POSITION	BUTTON	DESCRIPTION
11		Stop button. Works in MAN and SEM mode only. Press this button to initiate the stop sequence of the gen-set. Repeated pressing or holding the button for more than 2s will cancel current phase of stop sequence (like ramping the power down or cooling) and next phase will continue.
12		Fault reset button. Use this button to acknowledge alarms and deactivate the horn output. Inactive alarms will disappear immediately and status of active alarms will be changed to "confirmed" so they will disappear as soon as their reasons dismiss.
13		Horn rest button. Use this button to deactivate the horn output without acknowledging the alarms.
14		Start button. Works in MAN and SEM mode only. Press this button to initiate the start sequence of the engine.
15		Colour display, 320x240 pixels.

Page Structure

Display Screens and Pages Structure

The displayed information is structured into "pages" and "screens".

1. The pages Metering consists of screens which displays measured values like voltages, current, oil pressure etc., computed values like i.e. gen-set power, statistic data and etc.. Use arrows Up and Down buttons to switch over the pages.
2. The Setpoints screen contains all setpoints organized to groups and also a special group for entering password.
3. The History screen shows the history log in the order that the last record is displayed first.
4. Help/Others screen allows set-up languages, user access, IntelliVision 5 setting and etc..

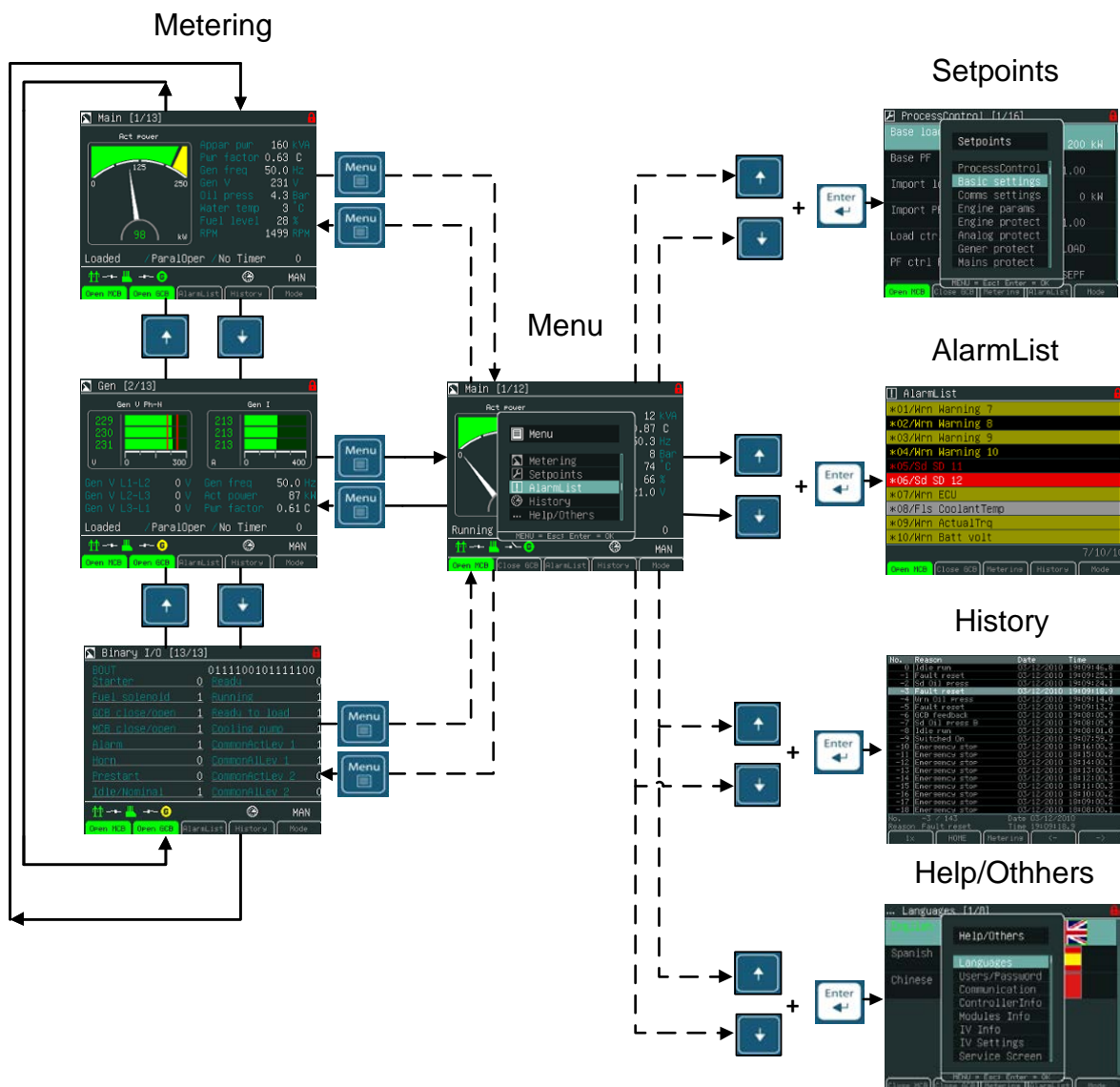

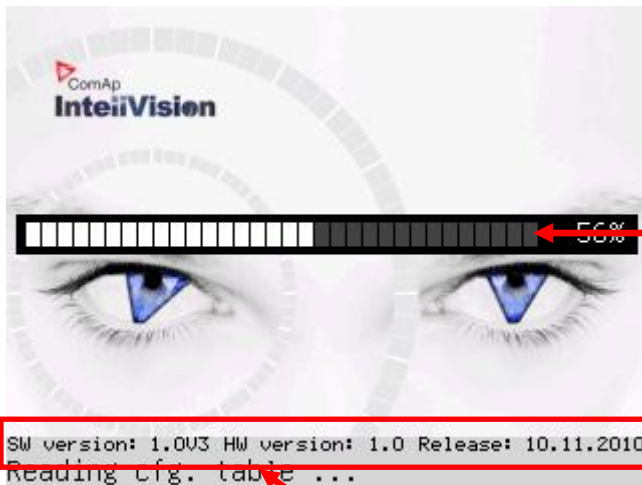

Connection



Configuration reading

IntelliVision 5 information SW, HW version and release date

Alarms

Alarms are structured into two levels and IntelliVision 5 allows easy interpreted their meaning based on the colour scheme. First level alarm (yellow lamp, warnings) is interpreted with yellow colour . Red colour  is used for all second level alarms (Red lamp, ShutDown,...). When an error occurs, a new alarm appears in the AlarmList screen, exclamation mark starts blinking on the metering screens.

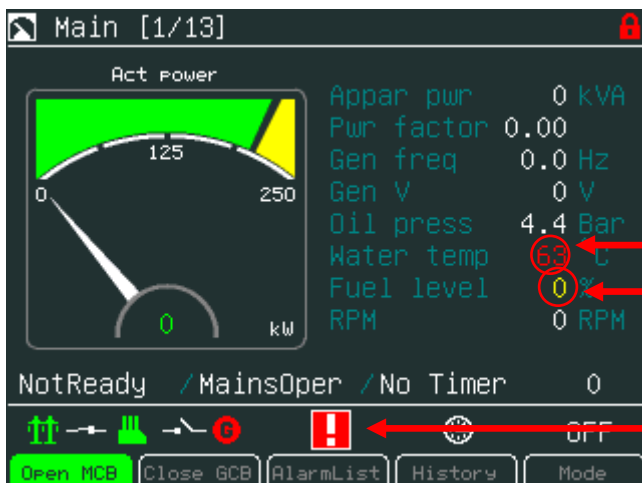

Second level alarm

First level alarm

Alarm indication

Direct button to AlarmList

Hint:

When a new alarm appears AlarmList screen is displayed automatically when the main/first Metering screen is displayed. From different screen, Alarm button has to be used to display AlarmList screen.

AlarmList Screen

AlarmList

- *01/Wrn Warning 7
- *02/Wrn Warning 8
- *03/Wrn Warning 9
- *04/Wrn Warning 10
- *05/Sd SD 11
- *06/Sd SD 12
- *07/Wrn ECU
- *08/FIs CoolantTemp
- *09/Wrn ActualTrq
- *10/Wrn Batt volt

7 10 10

Open MCB Close GCB Metering History Mode

Active unacknowledged first level alarm

Inactive unacknowledged first level alarm

Inactive unacknowledged second level alarm

Active unacknowledged second level alarm

Active ECU alarm

Sum of all alarms

Sum of unacknowledged active and inactive alarms

Number of active alarms

Alarm activated with analogue value

Analog Inputs [11/13]

Oil Press Water temp Fuel level Sec Wtemp

Bar °C % °C

4.4 63 44 63

10.0 150 100 200

3.0 50 10 50

1.0 50 10 50

0.0 0 0 0

Shutdown / MainsOper / Stop time 58

MAN

Open MCB Close GCB AlarmList History Mode

Second level alarm

First level alarm

Alarm activated with binary inputs

Binary I/O [12/13]

BIN 0101001100000000

GCB feedback 0 Warning 9 0

MCB feedback 1 Warning 10 0

Remote S/S 0 SD 11 0

Emergency stop 1 SD 12 0

AccessLock int 0 SD 13 0

Remote OFF 0 SD 14 0

Warning 7 1 SD 15 0

ShutDown 1 SD 16 0

OFF

Open MCB Close GCB AlarmList History Mode

First level alarm

Second level alarm

Setpoint Change

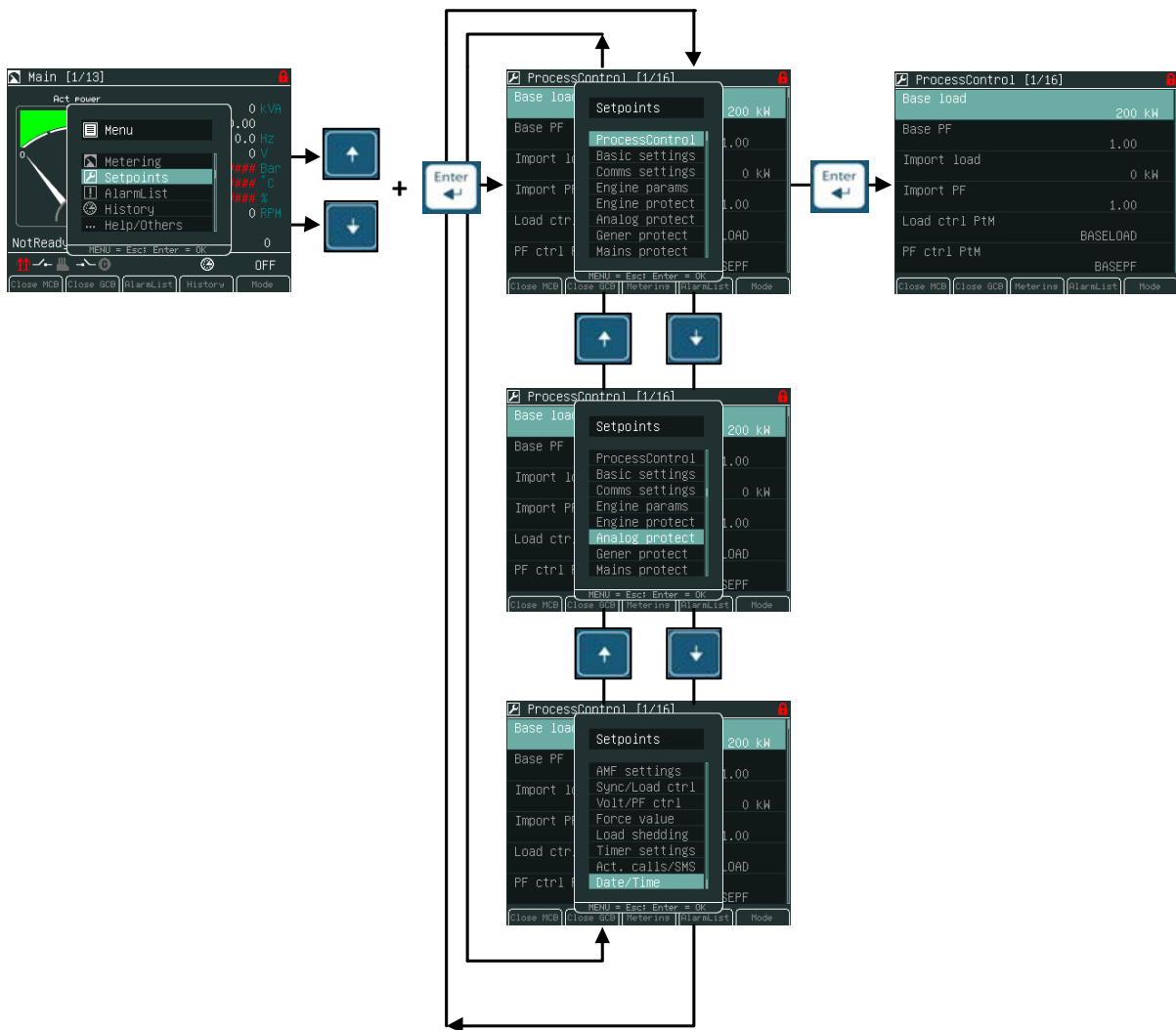

Hint:

Setpoints marked with a padlock icon  are password protected. **Enter** password as described in the chapter [Entering the Password](#) below.

Entering the Password

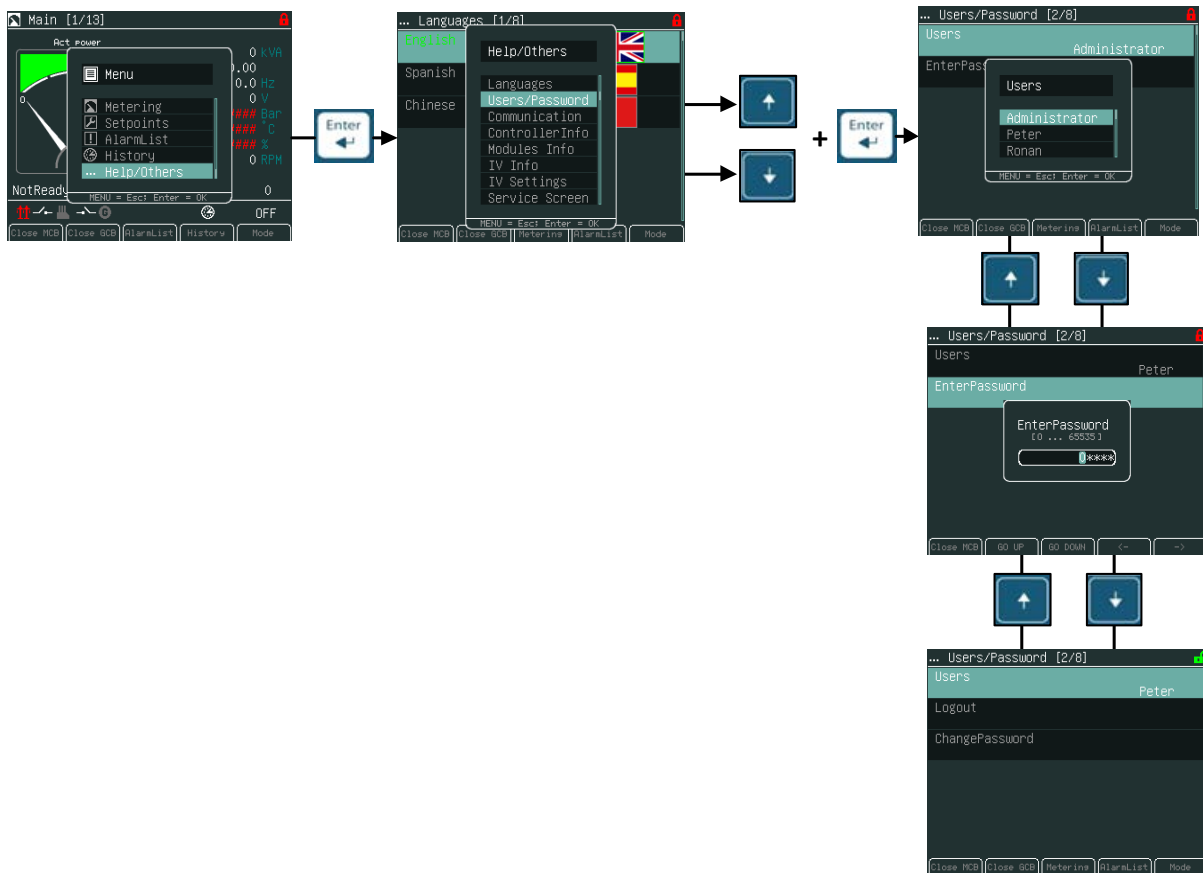

Locked Display and Setpoints



Hint:

Log in? Password dialog has to be open and then use → or ← for position and for the field use ↑ or ↓.

Password is a five-digit number (0 - 65535). Only setpoints associated with the entered password level can be modified. Display is locked automatically when no action is done within 15 minutes.

Hint:

Break through password protection

- Break through password function can be ENABLED/DISABLED from the password management window in IntelliMonitor (initial status is DISABLED).
- Warning "PassInsertBlick" appears in alarm list when controller is blocked
- It is not allowed to insert the password in case that controller is blocked. There is information that controller is blocked for next password attempt and time remaining till the end of blocation instead of password input window at the terminal screen.
- The controller is locked for 5 minutes when the password is 6 times wrong entered (in case of next 6 wrong attempts (correct password was not inserted at all) for 30, 60, 120, 240 minutes). *Incorrect password* message appears in the history of the controller when the invalid password is used.

Unlocked Display and Setpoints

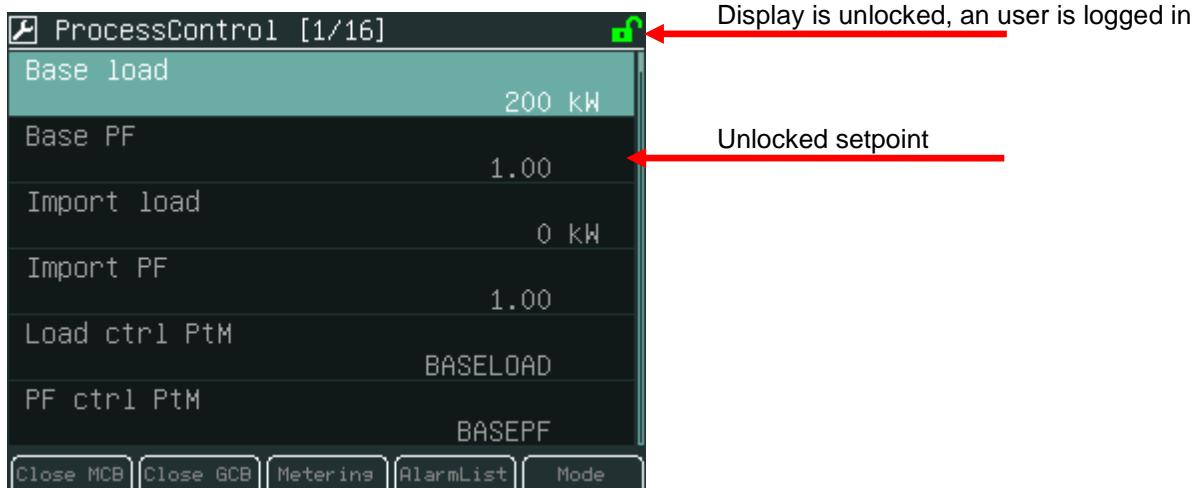

For setpoints change use arrows ↑ or ↓ to go to a certain setpoint (e.g. Base load) and press **Enter** button, see pictures below:

Numeric Setpoint Change

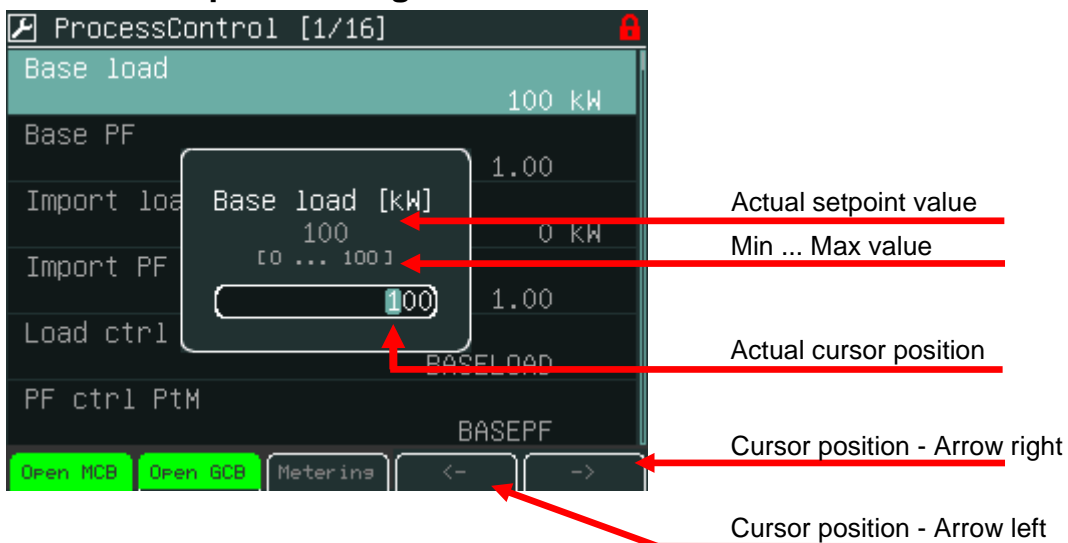

Use → or ← buttons to go to a certain position of the field and use ↑ or ↓ buttons to change the value. Then use **Enter** button to confirm new value.

Hint:

If you set the value out of limit, the field will get red colour and the new value is invalid. Invalid value cannot be confirmed.

String Selection

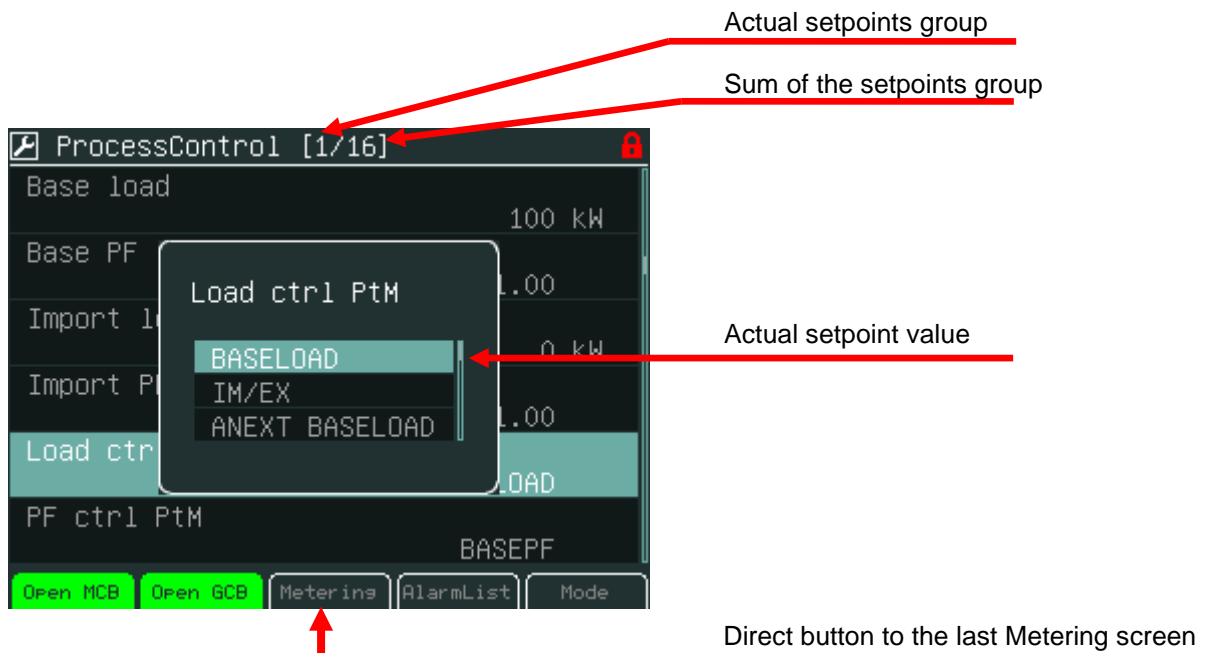

Use ↑ or ↓ buttons to select the string from the list and press the **Enter** button.

String Edit

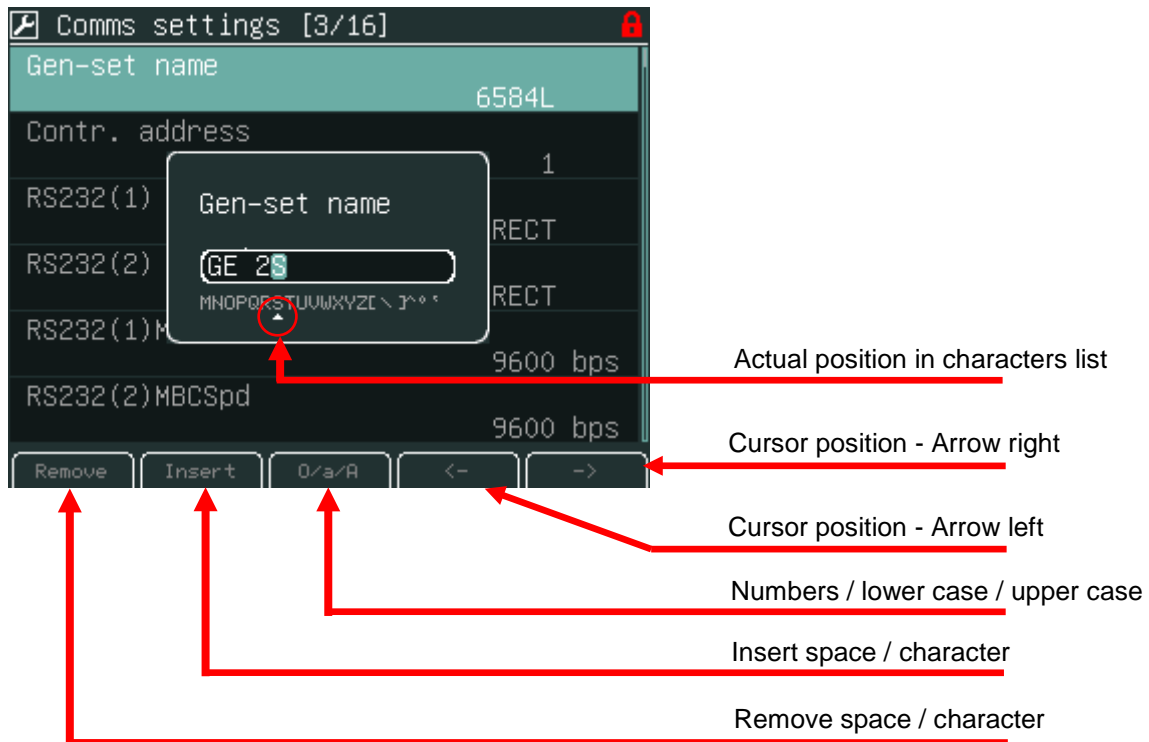

Use ↑ or ↓ buttons to select the character and → ← buttons for the next position and press **Enter** button.

Time and Date Edit

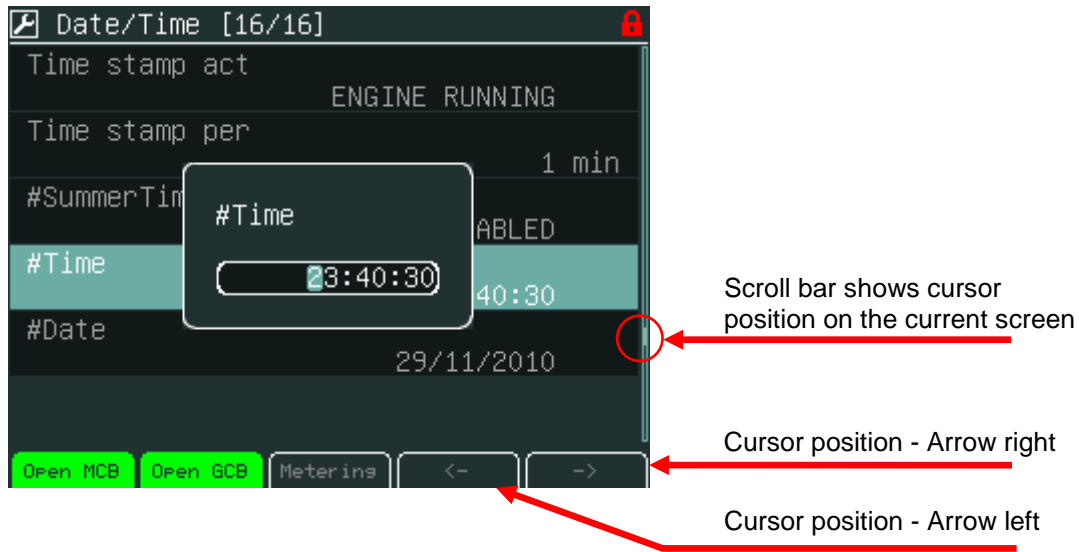

Use \uparrow \downarrow buttons to select the number, \rightarrow \leftarrow for the next position and press **Enter** button.

Combined Setpoints

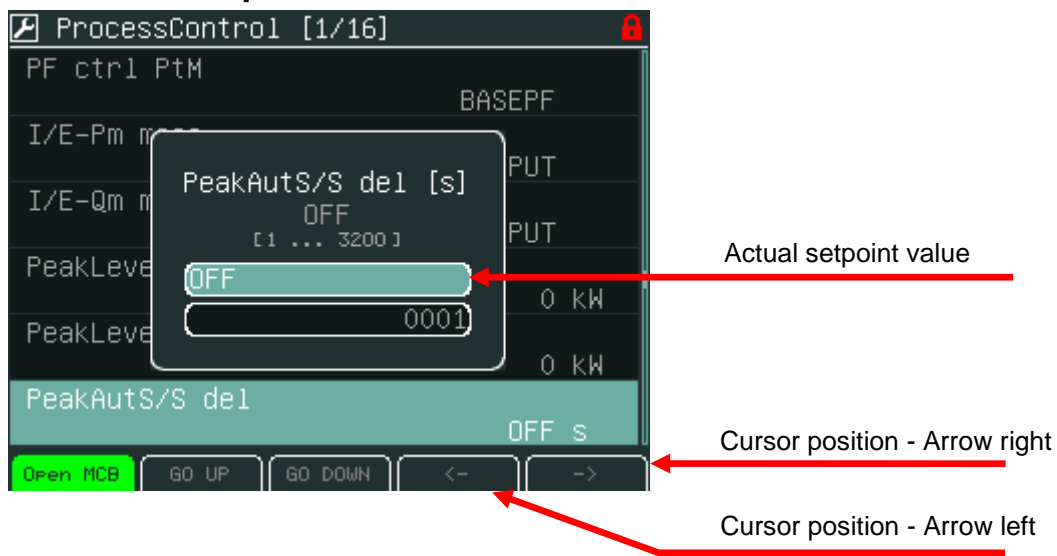

Use \uparrow or \downarrow buttons to select the number, \rightarrow or \leftarrow for the next position or go **Up** or go **Down** context buttons and press **Enter** button.

History

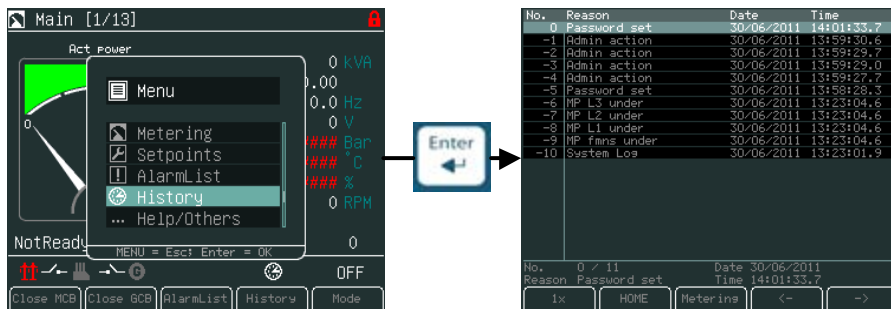

History page

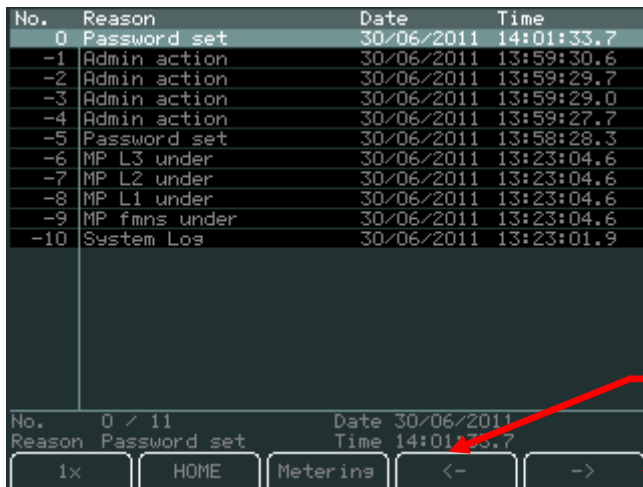

Display Contrast Adjustment

Display brightness could be set from the keyboard with button combination Menu button and ↑ or ↓.

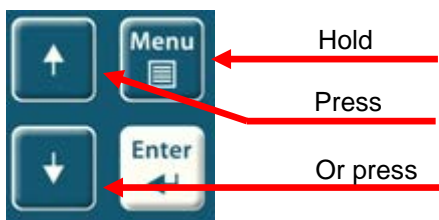

Two modes for backlight could be used day or night mode. Hold Menu button until the day or night pictogram appears.

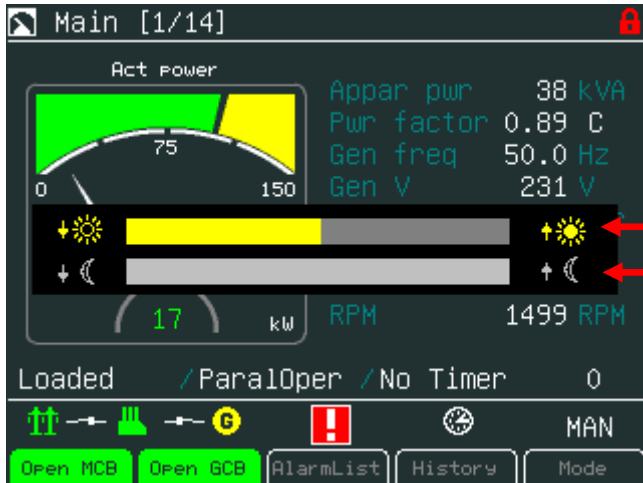

Day mode - active
Night mode - inactive

Hint:

Display backlight could be switched off due to Backlight Time. For recovery any button has to be pressed. (see IV5 Settings).

Controller Information Screen



Hint:

Lost password? Display the information screen containing the serial number and password decode number as described in the picture bellow and send them to your local distributor.

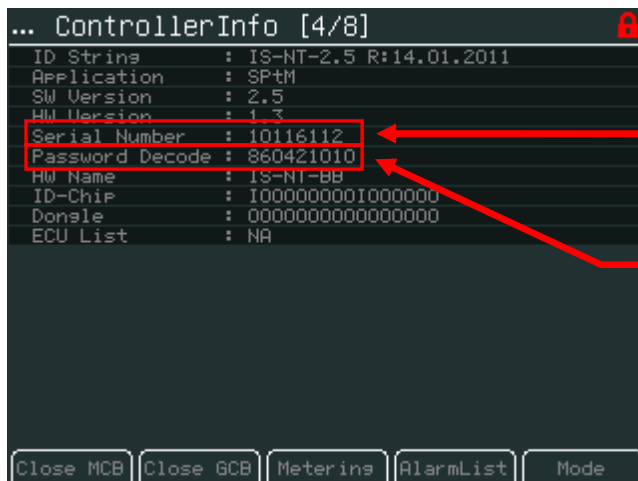





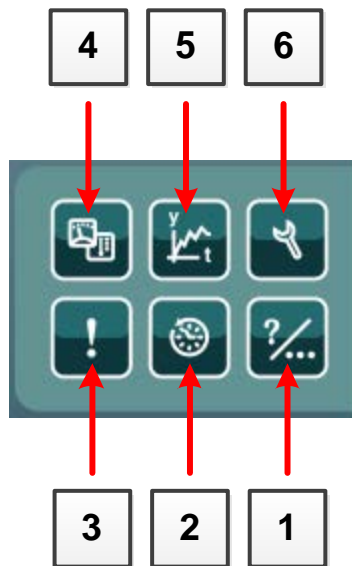

Serial number
Password decode

InteliVision 8



DIRECT BUTTONS (GROUP 1)



POSITION	BUTTON	DESCRIPTION
1		Help/Others - settings and information (users/passwords, communication, languages, IntelliVision 8 and controller info, IntelliVision 8 settings)
2		History button. Use this button to call controller history.
3		Alarm list button. Use this button to enter AlarmList.
4		Measurement button. Display actual values (power, synchro, analog. inputs, binary I/O, cylinders, engines, etc.)
5		Trends button. Use this button to go to the trends screen where chosen values in graphs/real time trends are displayed.
6		Setpoints button. Use to go to the setpoints group screen.

CONTEXT SENSITIVE BUTTONS (GROUP 2)

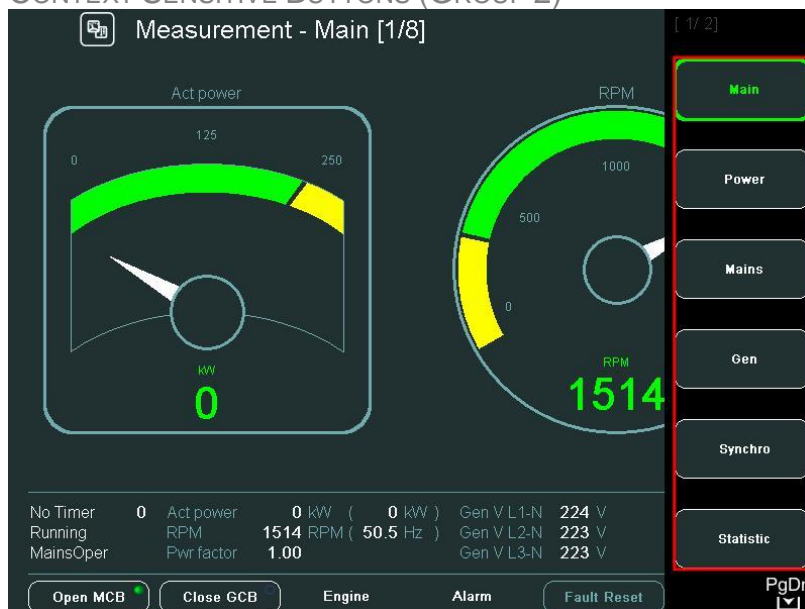

The context sensitive buttons allow display predefined screens when a suitable button is pressed. Meaning of the buttons depends on the Main menu option that is currently displayed (Metering, Trends and etc.) and on the controller firmware. The Picture above introduces standard SW IGS-NT-2.5.







Hint:

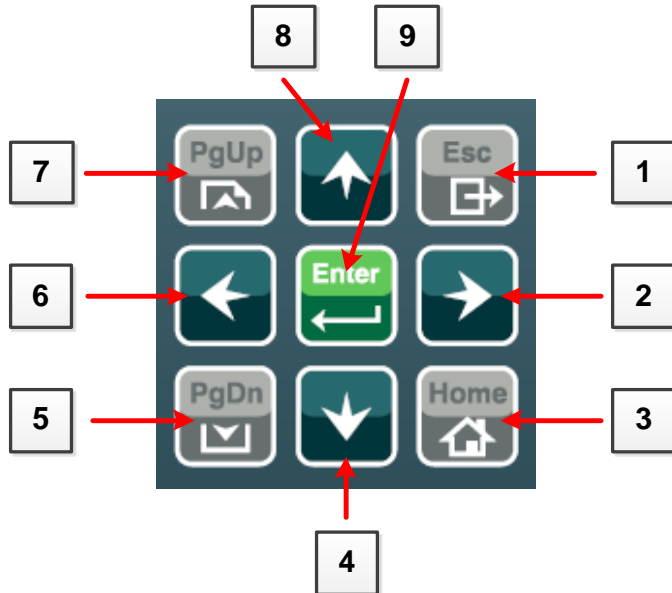

The icon  in the bottom right hand corner (see picture above) indicates possibility to use **PgDn** button to see next items of the context menu.

Navigation Buttons

There are nine navigation buttons:



POSITION	BUTTON	Description
1		ESC button. Escape from any dialog window or menu (cancels an action).
2		Right button. Use this button to move the cursor to the right, scroll to the right history page and etc.
3		Home button. Jump to Home screen. Main Metering screen is used in default configuration.
4		Down button. Use this button to move down, scroll down the screens or decrease a value.
5		PgDn button. Use this button to quickly go down among Metering screens or Setpoints groups (when menu is active) or among Setpoints or History records (when menu is not active).
6		Left button. Use this button to move the cursor to the left, scroll to the left history page and etc.
7		PgUp button. Use this button to quickly go up among Metering screens or Setpoints groups (when menu is active) or among Setpoints or History records (when menu is not active).



8		Up button. Use this button to move up, scroll up the screens or increase a value.
9		Enter button. Use this button to confirm a value or opens a value adjustment within setting dialogs.





Hint:

To leave the context menu, use Esc, **Enter** or ↑ ↓ → ← buttons.



GEN-SET CONTROL BUTTONS

POSITION	BUTTON	DESCRIPTION
4		STOP button. Works in MAN mode only. Press this button to initiate the stop sequence of the gen-set. Repeated pressing or holding the button for more than 2s will cancel current phase of stop sequence (like ramping the power down or cooling) and next phase will continue.
5		START button. Works in MAN mode only. Press this button to initiate the start sequence of the engine (MAN and SEM mode only).
6		HORN RESET button. Use this button to deactivate the horn output without acknowledging the alarms.

POSITION	BUTTON	DESCRIPTION
8		Mode button. Use this button to call mode change.*
9		Fault reset button. Use this button to acknowledge alarms and deactivate the horn output. Inactive alarms will disappear immediately and status of active alarms will be changed to “confirmed” so they will disappear as soon as their reasons dismiss.*
12		GCB button. Works in MAN mode only. Press this button to open or close the GCB manually. Note that certain conditions must be valid otherwise GCB closing is blocked.*
13		MCB button. Works in MAN mode only. Press this button to open or close the MCB manually.* CAUTION! You can disconnect the load from the mains supply with this button! Be sure you know well what you are about to do!
14		Colour display, 800x600 pixels.

* - It is valid in default SPtM configuration only. Screens description and buttons from 8 to 13 could have different meaning in customized versions or SW branches.

INTELIVISION 8 LED INDICATION

POSITION	DESCRIPTION
7	POWER indication. LED diode turns on when IntelliVision 8 is powered up.
10	Alarm indication. Alarm LED indication indicate alarms. Yellow colour for the first level alarms and red colour for the second level alarms. <i>Hint:</i> LED diode blink when at least one acknowledge alarm is present in the Alarm List. LED diode lights when alarms were acknowledged but are still active.
11	Engine indication. Engine LED indication lights only when engine is running.

Hint:

When you switch on IntelliVision 8 display, **Power** LED turns on and **Engine** and **Alarm** LEDs start to blink for a while.

Page Structure

Display Screens and Pages Structure

The displayed information is structured into "pages" and "screens".

1. The pages Metering consists from pages which displays measured values like voltages, current, oil pressure etc., computed values like i.e. gen-set power, statistic data and etc.. Use arrows Up and Down buttons to switch over the pages.
2. The Setpoints screen contains all setpoints organized into the groups and also a special group for entering password.
3. The History screen shows the history log in the order that the last record is displayed first.

Metering pages structure

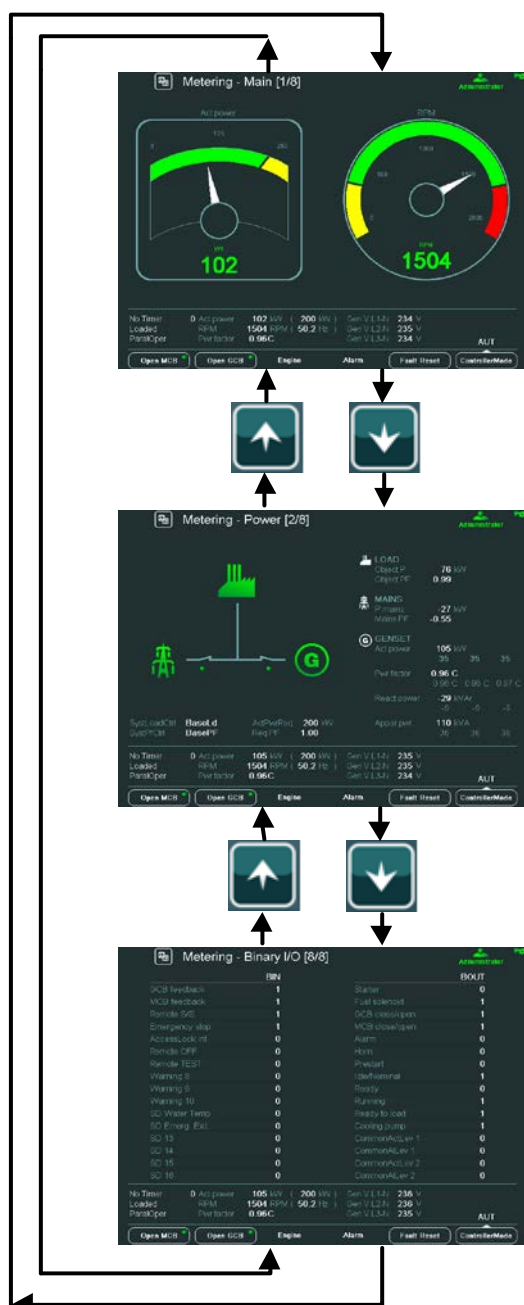

Connection



Configuration reading

InteliVision 8 core information

Serial number and release date

InteliVision 8 SW and HW version

InteliVision 8 is not connected

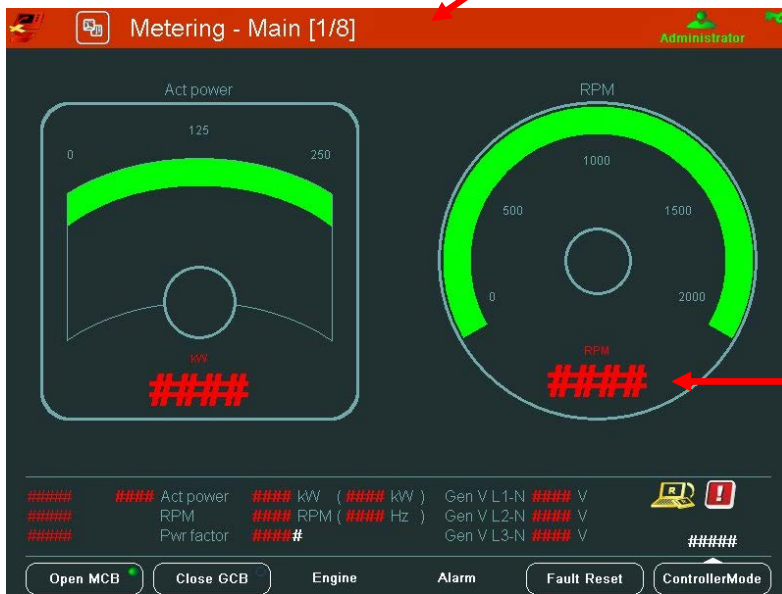

Not available value

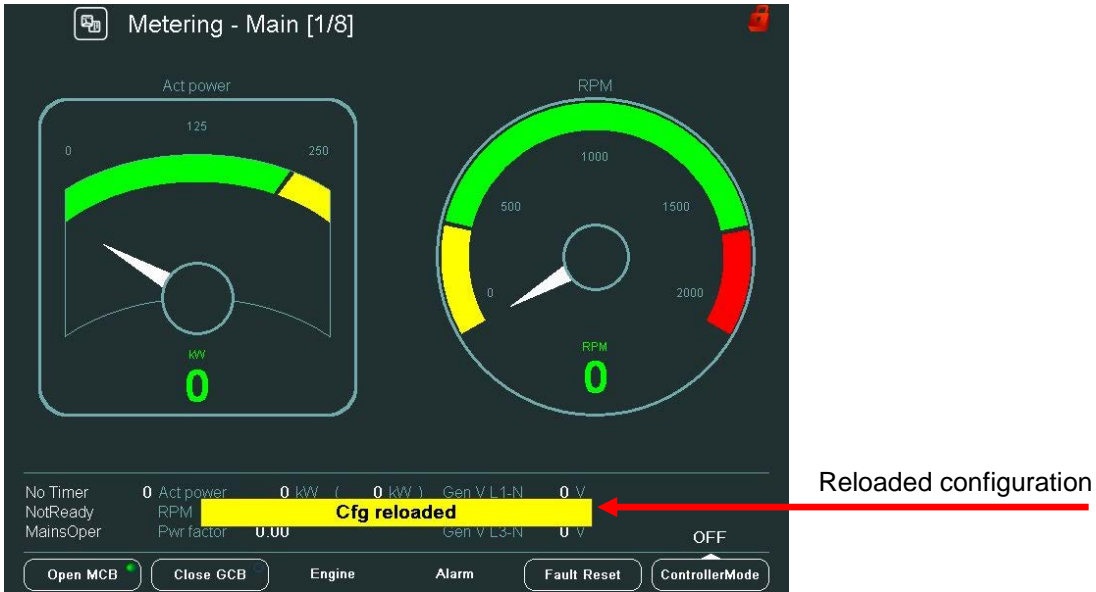

Alarms

Alarms are structured into two levels and IntelliVision 8 allows easy interpreted their meaning based on the colour scheme. When an error occurs, a new alarm appears in the **AlarmList** screen, exclamation mark starts blinking on the metering screens. When all alarms are acknowledged, the exclamation stops blinking and is on.

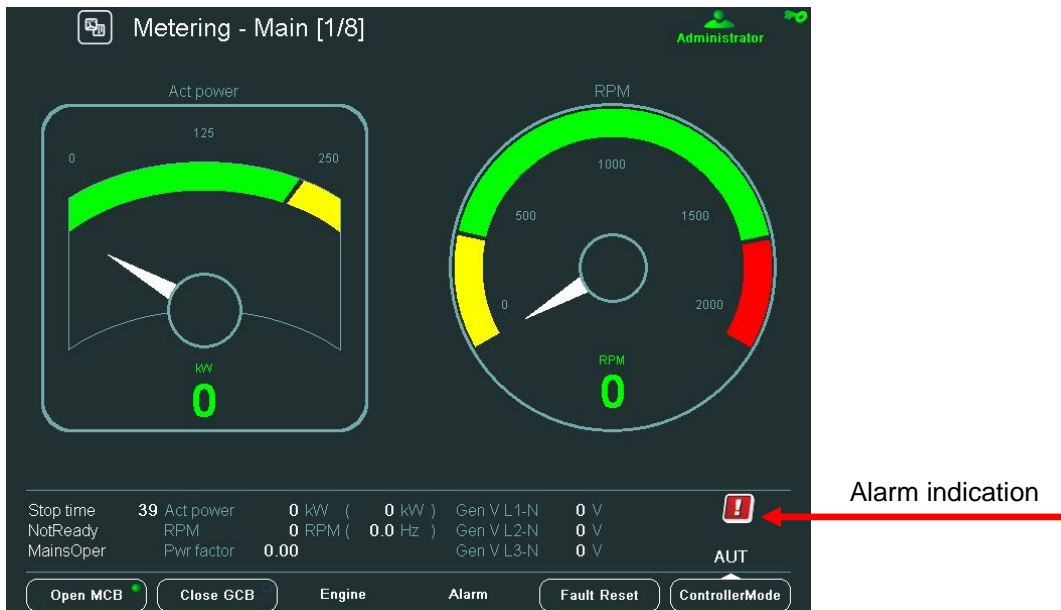

Hint:

When a new alarm appears **AlarmList** screen is displayed automatically when the main/first Metering screen is displayed. From different screen, **AlarmList** button has to be used to display **AlarmList** screen.

AlarmList Screen

1. Sd SD Emerg. Exit 9

2. Sd SD 14 10

3. Wrn Warning 9 11

4. Sd SD Water Temp 12

5. Sd SD 13 13

6. Wrn Warning 8 14

7. 15

8. 16

4 / 4 / 6

0 Act power 0 kW (0 kW) Gen V L1-N 0 V
 NotReady RPM 0 RPM (0.0 Hz) Gen V L2-N 0 V
 BrksOff Pwr factor 0.00 Gen V L3-N 0 V

MAN

Close MCB Close GCB Engine Alarm Fault Reset ControllerMode

Active acknowledged alarm

Active unacknowledged alarm

Inactive unacknowledged alarm

Sum of all alarms

Sum of unacknowledged alarms

Number of active alarms

Hint:

Use **Fault** reset button to confirm alarm in the **AlarmList**.

Metering - Binary I/O [8/8]

Administrator

BIN	BOUT
GCB feedback 0	Starter 0
MCB feedback 1	Fuel solenoid 0
Remote S/S 1	GCB close/open 0
Emergency stop 1	MCB close/open 1
AccessLock int 0	Alarm 1
Remote OFF 0	Horn 0
Remote TEST 0	Prestart 0
Warning 8 0	Idle/Nominal 0
Warning 9 0	Ready 0
Warning 10 1	Running 0
SD Water Temp 0	Ready to load 0
SD Emerg. Exit 1	Cooling pump 1
SD 13 0	CommonActLev 1 1
SD 14 0	CommonAllLev 1 1
SD 15 0	CommonActLev 2 1
SD 16 0	CommonAllLev 2 1

62 Act power 0 kW (0 kW) Gen V L1-N 0 V
 NotReady RPM 0 RPM (0.0 Hz) Gen V L2-N 0 V
 MainsOper Pwr factor 0.00 Gen V L3-N 0 V

AUT

Open MCB Close GCB Engine Alarm Fault Reset ControllerMode

First level alarm

Second level alarm

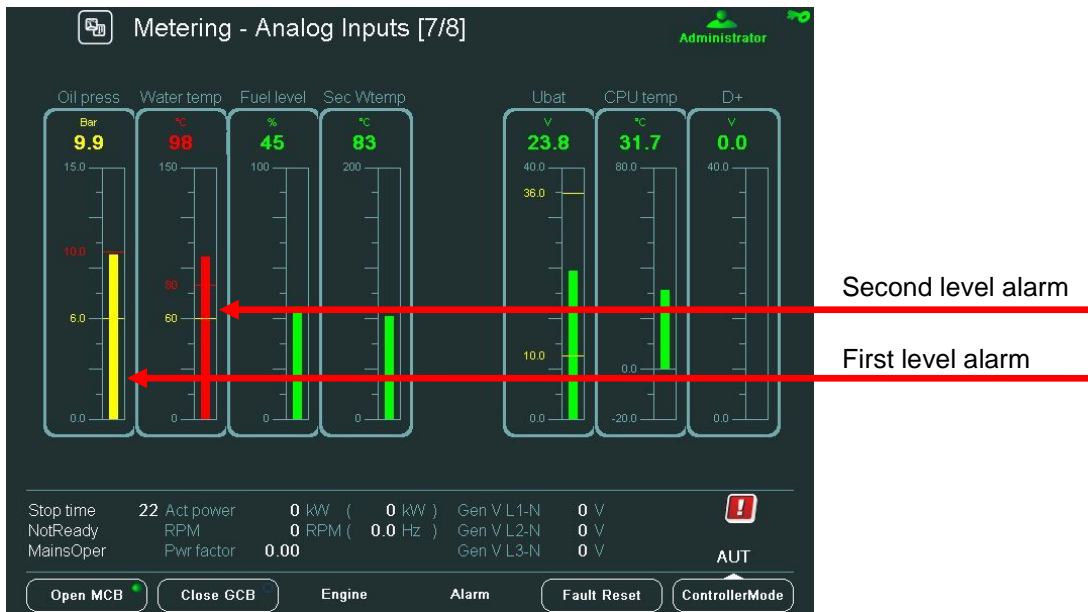

Setpoint Change

On Setpoints screens you can set various setpoints. To go to Setpoints screen press **Setpoints** button. Setpoints screen appears with the context sensitive buttons for the the setpoints group.



Hint:

Content of the context buttons list depends on the type of the application. To be more familiar with setpoints, see Reference Guide of the specific application (e.g.IGS-NT-SPTM-2.5-Reference Guide.pdf or IGS-NT-MINT-2.5-Reference Guide.pdf).

Change of the Numerical Value

Use →, ← buttons to go to a certain position of the field and use ↑ ↓ to change the value. Then confirm your settings with **Enter** button.

Hint:

If the value is out of limit, the field will color red and the value could not be confirmed.

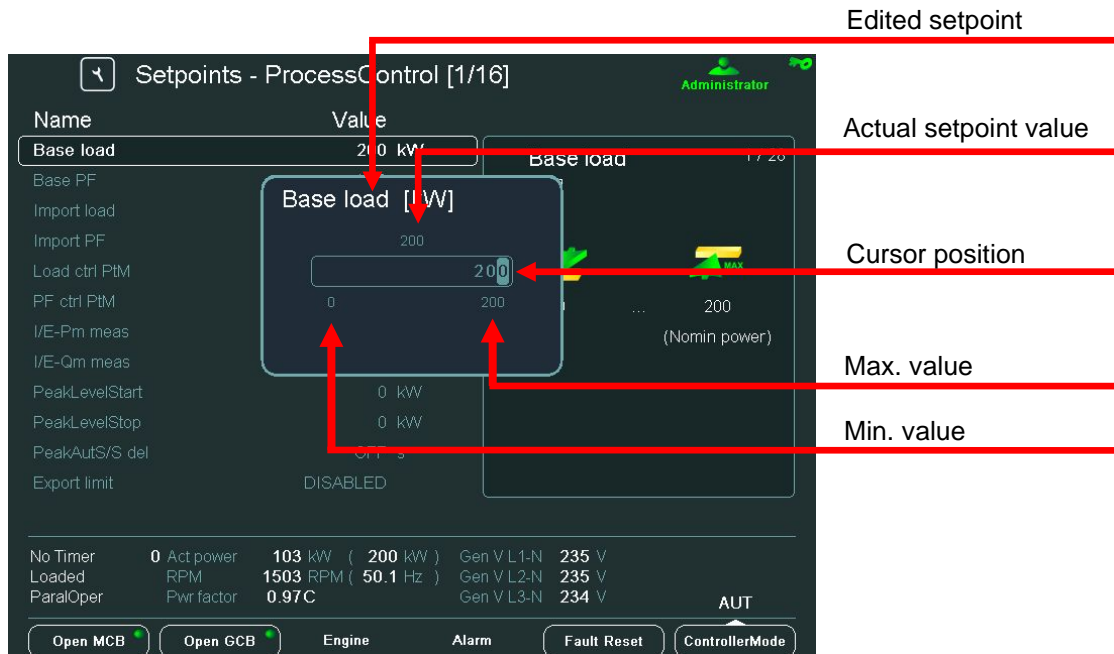

String Selection

Use ↑ ↓ to go to a certain setpoint and press **Enter**, see picture below:

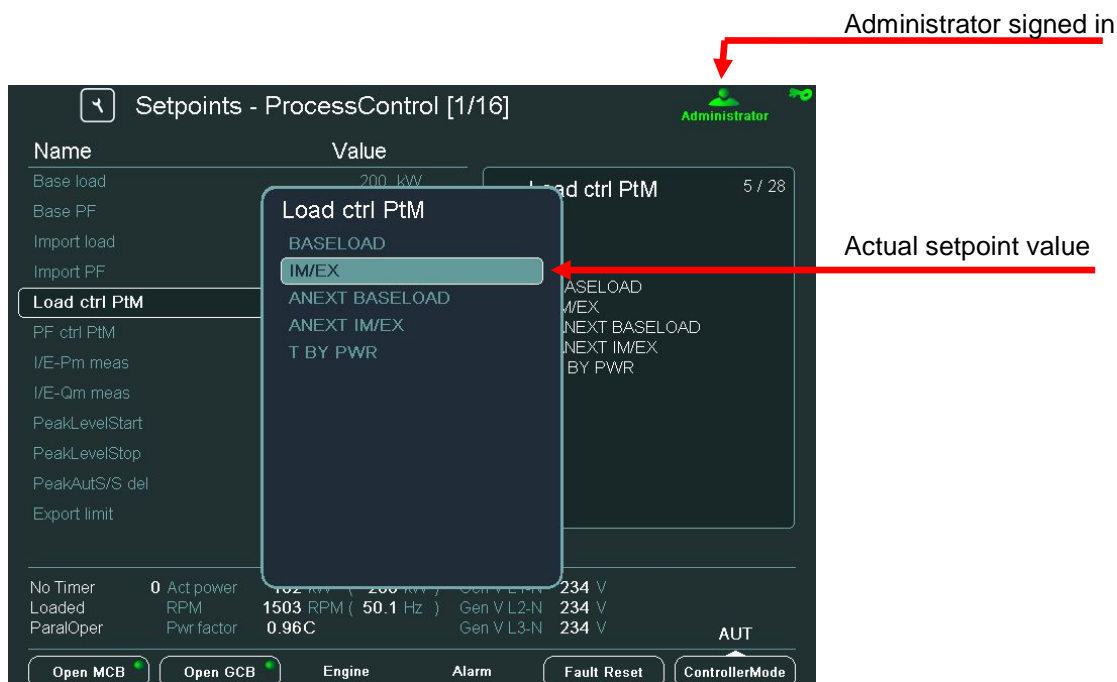

String Edit

The characters set table appears on the screen when string will be edited (like gen-set name). Use → ← and ↑ ↓ to find the position, then press  button to confirm text.

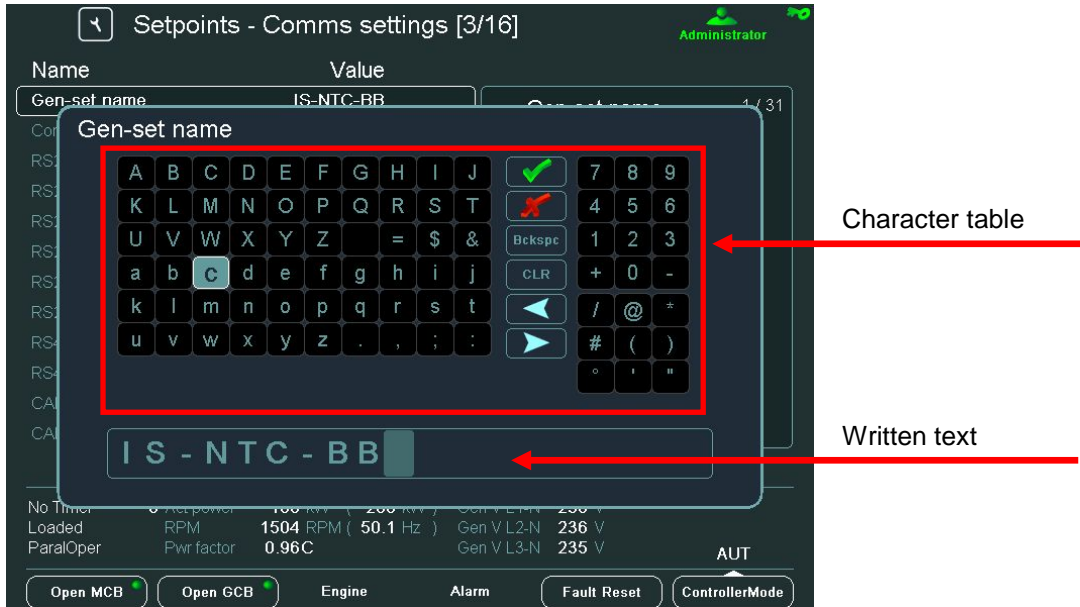

Time and Date Edit

Date and Time are edited as the numerical value. See [Change of the Numerical Value](#).

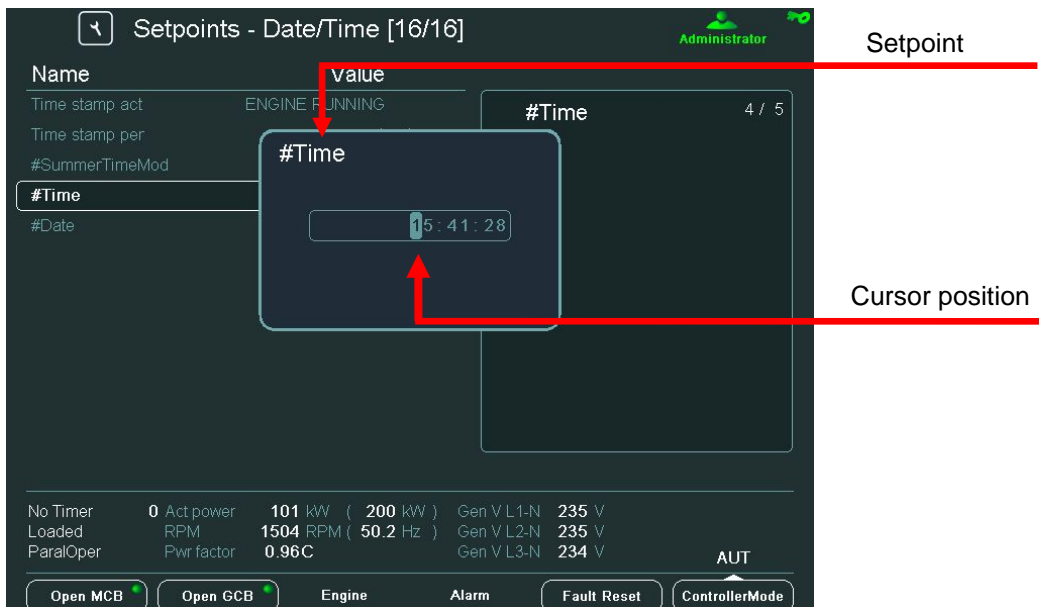

Combined Setpoints

The screenshot shows the 'Setpoints - ProcessControl [1/16]' interface. A modal window for 'PeakAutS/S del [s]' is open, showing a value of '0.001'. Red arrows point to the cursor position, the setpoint value, and an unlocked setpoint field.

Name	Value
I/E-Pm meas	IM3 CT INPUT
I/E-Qm meas	
PeakLevelStart	
PeakLevelStop	
PeakAutS/S del	OFF
Export limit	1
Derating1 strt	0 x
Derating1 end	0 x
Derating1 pwr	50 %
Derating2 strt	0 x
Derating2 end	0 x
Derating2 pwr	50 %

Actual cursor position

Actual setpoint value

Unlocked setpoint

0 Act power 106 kW (200 kW) Gen V L1-N 235 V
 Loaded RPM 1504 RPM (50.1 Hz) Gen V L2-N 235 V
 ParalOper Pwr factor 0.96C Gen V L3-N 234 V

AUT

Open MCB Open GCB Engine Alarm Fault Reset ControllerMode

Use Left or Right buttons to move between the cells. Use Left or Right arrow to change cursor position.

Entering the password

User has to be logged in before setpoint is changed. Use **Help/Others** button to open login dialogue, then use \uparrow \downarrow to go to **Users** field and **Password** then press **Enter**.

The screenshot shows the 'Help/Others - Users/Password' interface. A modal window for 'EnterPassword' is open, showing a password field with '00000' and a cursor. A red arrow points to the cursor position.

Cursor position

0 Act power 106 kW (200 kW) Gen V L1-N 236 V
 Loaded RPM 1503 RPM (50.1 Hz) Gen V L2-N 236 V
 ParalOper Pwr factor 0.96C Gen V L3-N 235 V

AUT

Open MCB Open GCB Engine Alarm Fault Reset ControllerMode

Hint:

Password is a five-digit number (0 - 65535). Only setpoints associated with the entered password level can be modified.

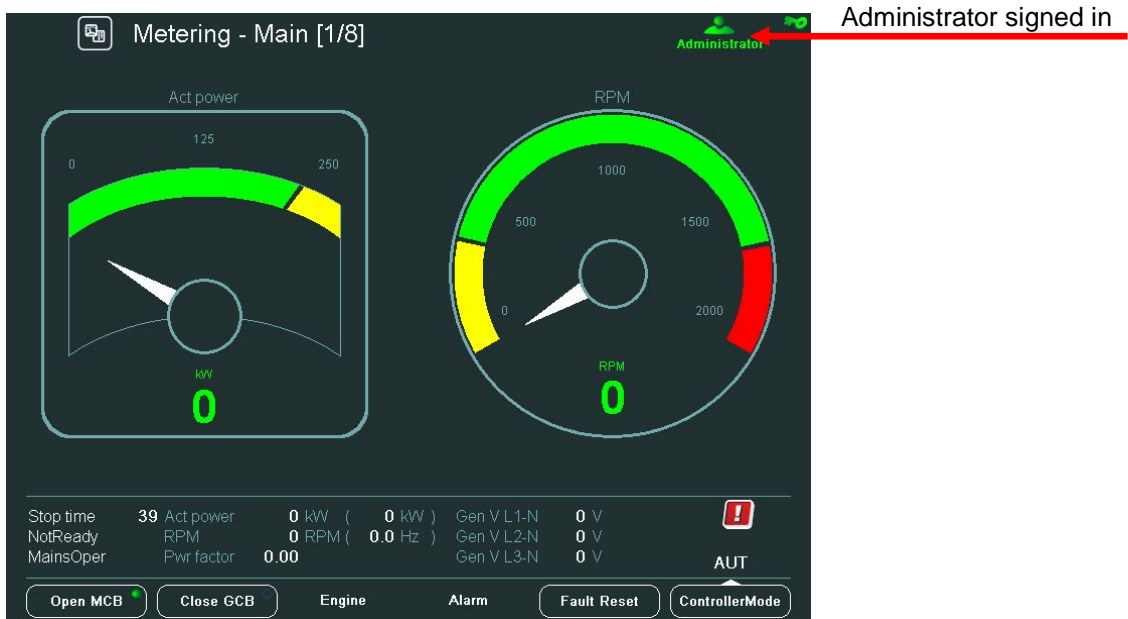

The icons in the top right-hand corner then show you that you are logged on.

History

Displayed values in columns

No.	Reason	Date	Time	RPM	Pwr	Q
0.	Loaded	14/07/11	15:37:29	1501	105	-31
-1.	GCB closed	14/07/11	15:37:24	1501	103	-29
-2.	Soft load	14/07/11	15:37:24	1501	103	-29
-3.	SyncStarted	14/07/11	15:37:12	1497	104	-28
-4.	Running	14/07/11	15:37:07	1490	107	-27
-5.	Time stamp	14/07/11	15:37:00	1261	111	-32
-6.	Idle run	14/07/11	15:36:57	411	0	0
-7.	Gen Rem start	14/07/11	15:36:55	0	0	0
-8.	Ready	14/07/11	15:36:55	0	0	0
-9.	Fault reset	14/07/11	15:36:25	0	0	0
-10.	PreAlarm stamp	14/07/11	15:35:41	0	0	0
-11.	PreAlarm stamp	14/07/11	15:35:38	0	0	0
-12.	PreAlarm stamp	14/07/11	15:35:35	0	0	0
-13.	PreAlarm stamp	14/07/11	15:35:32	0	0	0
-14.	PreAlarm stamp	14/07/11	15:35:29	0	0	0
-15.	PreAlarm stamp	14/07/11	15:35:26	0	0	0
-16.	PreAlarm stamp	14/07/11	15:35:23	0	0	0
-17.	PreAlarm stamp	14/07/11	15:35:20	0	0	0

Actual line (row) with the appropriate values in the history log

HISTORY CONTEXT BUTTONS

POSITION	DESCRIPTION
1	First Row/Col. Use to jump to the first column and first row (the first column is RPM – you cannot move among columns Reason , Date and Time)
2	First Row. Use to jump to the first row.
3	First Col. Use to jump to the first column.
4	Last Col. Use to jump to the last column.
5	PageMode On. Use this button when the PageMode is ON you can use → ← buttons to jump by page right or left (quicker movement through columns). Icon  at the top of the screen indicates that PageMode is On.

Display Contrast Adjustment

From the mains screen the day or night mode can be choose. The mode is switched when ESC button is pressed for one second. The brightness is adjustable in the full range of 0 % - 100 % in the both modes. The display brightness can be increased/decreased by holding **Esc** button and repeated pressing ↑ ↓. See picture below:

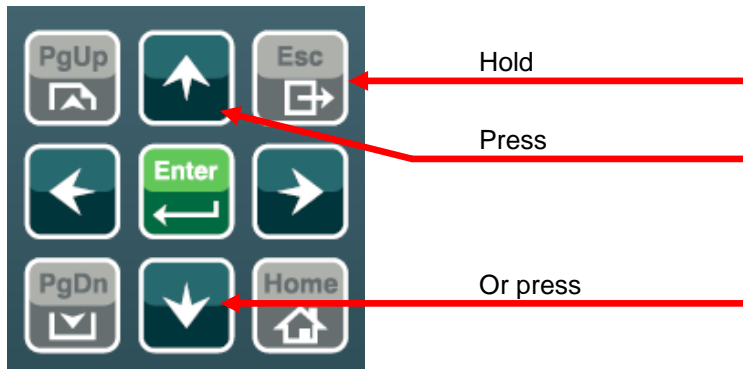

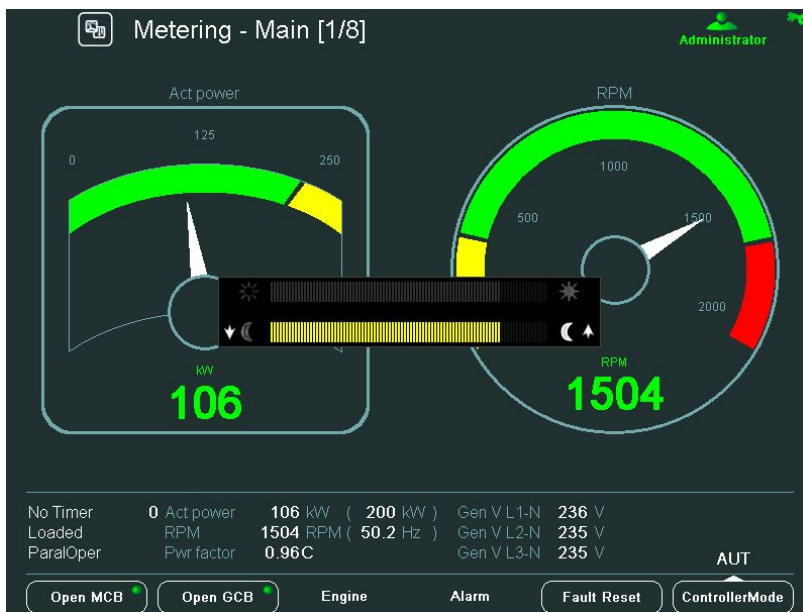
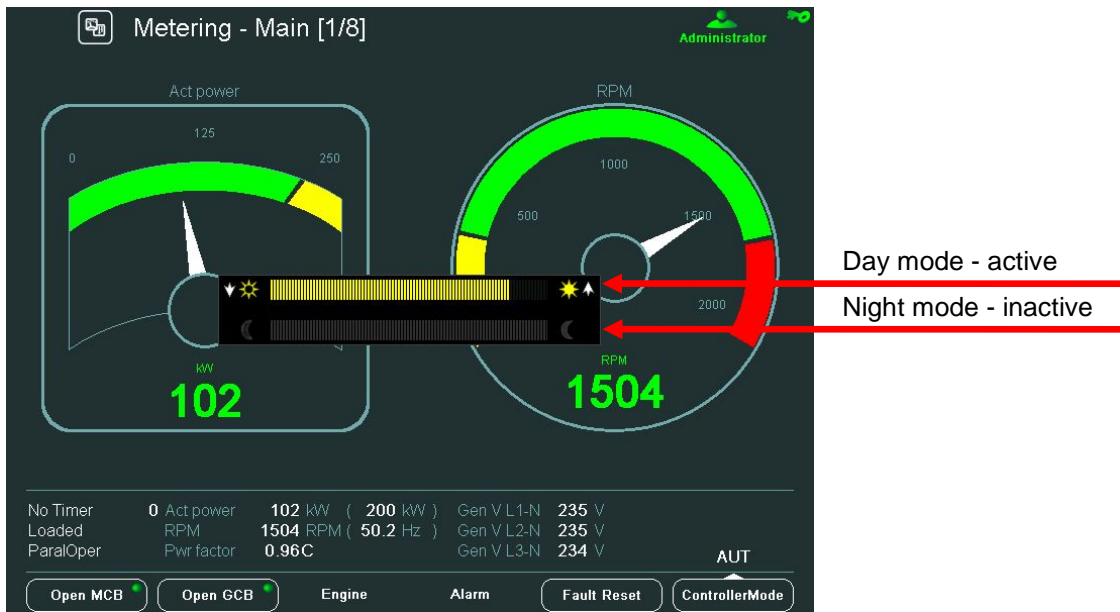

When brightness dialogue is active, use **ESC + PgUp** buttons or **ESC + PgDn** to switch between modes, which shall be adjusted.

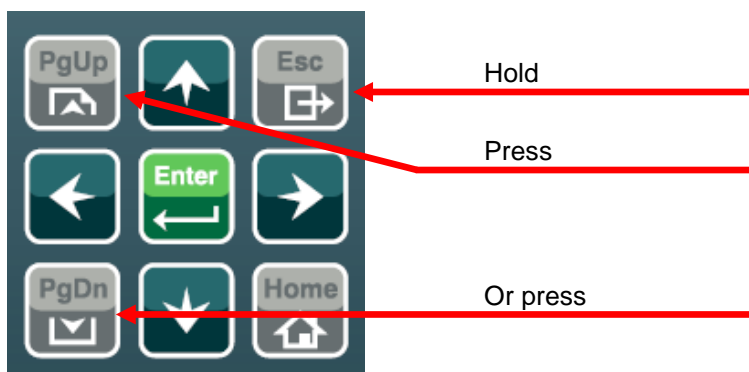

Controller Information Screen

Help/Others - ControllerInfo

ID String: IS-NT-2.5 R:14.01.2011 Connected Modules:

Appl:	Num.Type	SW Ver.	HW Ver.	Address
SPTM	01	IB.COM	1.0	NA

SW Version: 2.5
HW Version: 2.0
Serial Number: 10100269
HW Name: IS-NTC-BB
ID-Chip Properties: 1000000001000000
Dongle Properties: 0000000000000000

No Timer	0 Act power	106 kW (200 kW)	Gen V L1-N	235 V
Loaded	RPM	1503 RPM (50.1 Hz)	Gen V L2-N	235 V
ParalOper	Pwr factor	0.96C	Gen V L3-N	235 V

AUT

Open MCB Open GCB Engine Alarm Fault Reset ControllerMode

Help/Others - IV Info

ComAp Copyright (C) 2008-2011

SW Version: 1.2.5
HW Version: 1.1
Release Date: 04.02.2011
Serial Number: 10100544
IVCom SW Version: 1.3
Core Version: 1.2.5.1 (NA)
Core Platform: CM-X300-CEB
Power Voltage: 24.3 V
Board Temperature: 35.6 °C
IV load balance: 0 / 3
Memory: 32244 kB / 6064 kB / 82 %

Num.	Object	Code	Cnt
0	0	0	0

Supported Languages:

- ANSI/OEM United States
- ANSI/OEM Thai
- ANSI/OEM Japanese Shift-JIS
- ANSI/OEM Chinese Simplified GBK
- ANSI/OEM Korean
- ANSI/OEM Chinese Traditional Big5
- ANSI Central European
- ANSI Cyrillic
- ANSI Latin 1
- ANSI Greek
- ANSI Turkish
- ANSI Hebrew
- ANSI Arabic
- ANSI Baltic
- ANSI/OEM Vietnamese

No Timer	0 Act power	104 kW (200 kW)	Gen V L1-N	234 V
Loaded	RPM	1503 RPM (50.1 Hz)	Gen V L2-N	234 V
ParalOper	Pwr factor	0.97C	Gen V L3-N	234 V

AUT

Open MCB Open GCB Engine Alarm Fault Reset ControllerMode

InteliGen^{NT} GC and InteliSys^{NT}

InteliGenNTGC pushbuttons and LEDs

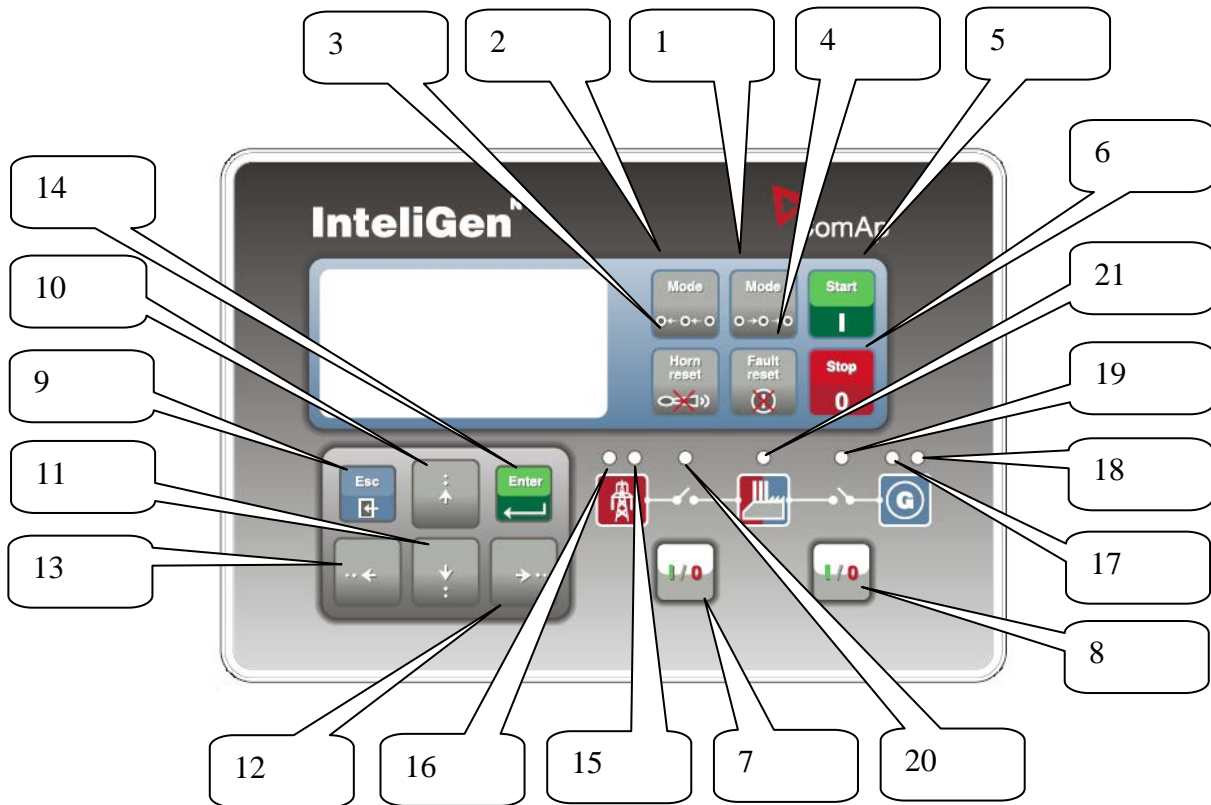







Pushbuttons:

1. **MODE→** Cycle forward through gen-set operation modes OFF→MAN→AUT→TEST.
2. **←MODE** Cycle backward through gen-set operation modes OFF←MAN←AUT←TEST.
3. **HORN RESET** Deactivates the HORN (AUDIBLE ALARM).
4. **FAULT RESET** Acknowledges faults and alarms.
5. **START** Starts the gen-set in MAN mode.
6. **STOP** Stops the gen-set in MAN mode.
7. **MCB ON/OFF** Opens and closes (synchronizes) the Mains circuit breaker in MAN mode.
8. **GCB ON/OFF** Opens and closes (synchronizes) the Generator circuit breaker in MAN mode.
9. **ESC**







Where	Function
Measurement screens, Alarm list	Go to Menu screen
Setpoints screen	Go to Menu screen; within setpoint











	group, go to group list
Setpoint edit	Leave setpoint edit without changes
History screen	Go to Menu screen
FastEdit screen	Fast edit exit (to previous measurement screen) without changes
Language screen	Language screen exit (to menu) without save

10.  Select the setpoint, select the screen, select history record or increase setpoint value.
11.  Select the setpoint, select the screen, select history record or decrease setpoint value.
12.  Moves history record displayed columns to the right, 5% increase of edited setpoint's value (step given by the setpoint range), go back from Alarm list.
13.  Moves history record displayed columns to the left, 5% decrease of edited setpoint's value (step given by the setpoint range), view Alarm list from measurement screens.
14. 

Where	Function
Menu screen	Go to selected display group (Measurement CU, Measurement IO, ...)
Measurement screens, Alarm list	Go to FastEdit screen (hold  for 4 sec.) – then it is possible to adjust selected setpoint (typically Base load for standard SPtM)
Setpoints screen	Go to selected setpoint group
Setpoint edit	Start setpoint edit / save changes
History screen	Go to the first column of the first history record
FastEdit screen	FastEdit exit (to previous measurement screen) with setpoint change
Language screen	Language screen exit (to menu) and save selection

Pushbuttons' combinations

Following table determines controller functions when , , , ,  and  buttons' combination is pressed:

Where	Pushbutton combination	Function
Measurement screens, Alarm list	 + 	Contrast increase
	 + 	Contrast decrease
	 + 	Info screen
Info screen	 + 	Backlight increase
	 + 	Backlight decrease

LEDs

15. MAINS VOLTAGE PRESENT: GREEN LED is on, if voltage on the mains terminals is present (in SPI and SPtM). LED is not active in MINT, COX.
16. MAINS FAILURE: RED LED starts flashing when the mains failure occurs and gen-set does not run, goes to steady light when the gen-set starts and goes off when the mains restores.
17. GEN VOLTAGE PRESENT: GREEN LED is on, if gen. voltage is present and within limits.
18. GEN-SET FAILURE: RED LED starts flashing when any failure occurs. After **FAULT RESET** button is pressed, goes to steady light (if an alarm is still active) or is off (if no alarm is active).
19. GCB ON: GREEN LED is on, if GCB feedback is active. Flashes during synchronizing.
20. MCB ON: GREEN LED is on, if MCB feedback is active. Flashes during reverse synchronizing (synchronizing of the loaded gen-set back to the restored mains).
21. Bus – GREEN LED is on if bus voltage is present and within limits.

InteliSysNT Basebox pushbuttons and LEDs

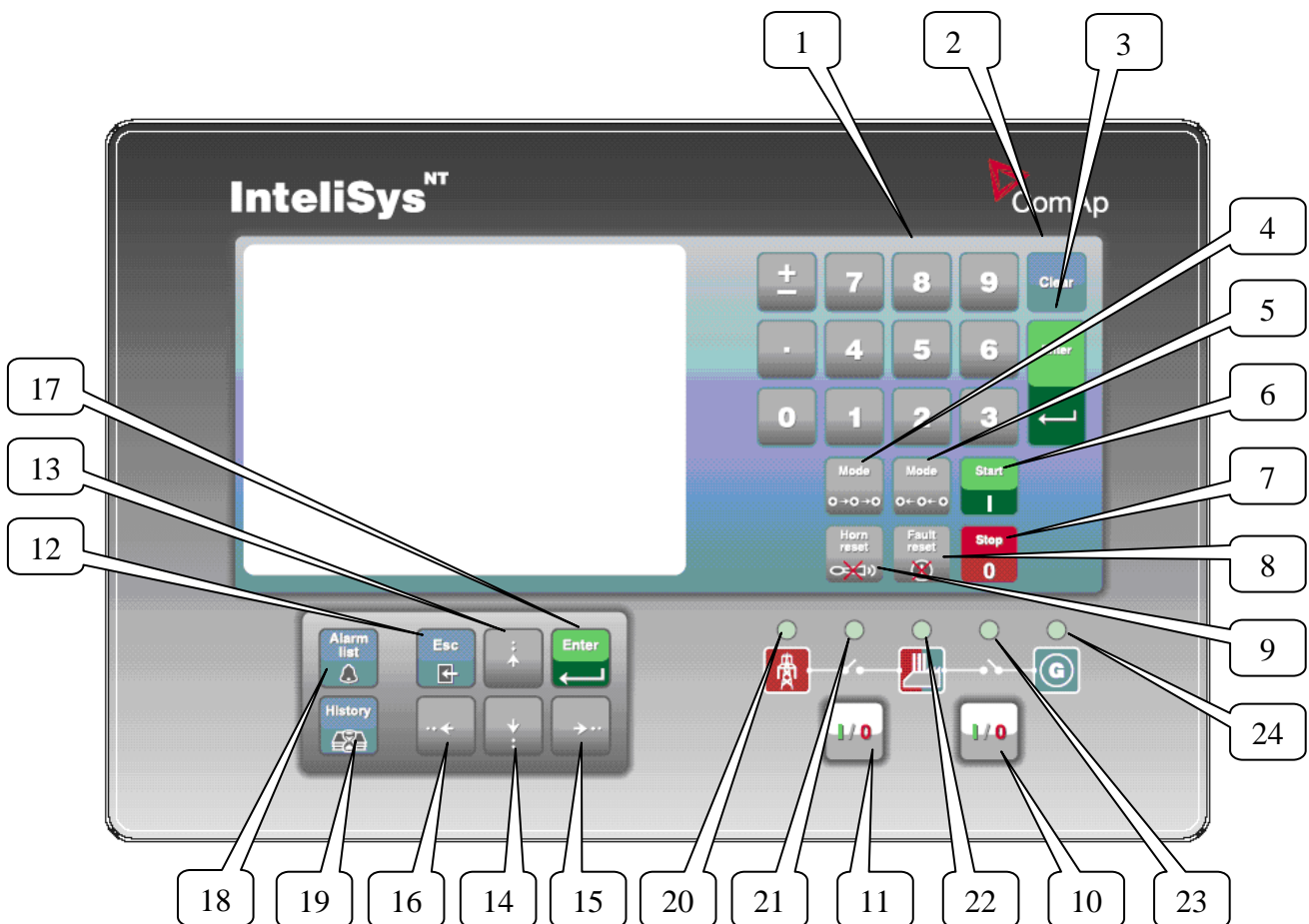

Pushbuttons:

1. Numeric keypad

Where	Function
Setpoints screen	Change setpoint value
Menu screen	Go to selected display group directly
Measurement screens	Go to another screen directly
Language screen	Select language directly
History screen	If pressed \pm button a \mathbb{E} symbol appears on the display (bottom right corner) and it is possible to move by one page of records using arrow buttons

2. **Clear**

Clears character on the left side of the cursor, exits from menu

3. **Enter**

Where	Function
Menu screen	Go to selected display group (Measurement CU, Measurement IO, ...)
Measurement screens, Alarm list	Go to FastEdit screen (hold ENTER for 4 sec.) – then it is possible to adjust selected setpoint (typically Base load for standard SPtM)
Setpoints screen	Go to selected setpoint group
Setpoint edit	Start setpoint edit / save changes
History screen	Go to the first column of the first history record
FastEdit screen	FastEdit exit (to previous measurement screen) with setpoint change
Language screen	Language screen exit (to menu) and save selection

4. **Mode→** Cycle forward through gen-set operation modes OFF→MAN→SEM→AUT→TEST.

5. **←Mode** Cycle backward through gen-set operation modes OFF←MAN←SEM←AUT←TEST.

6. **START** Starts the gen-set in MAN or SEM mode.

7. **STOP** Stops the gen-set in MAN or SEM mode.

8. **FAULT RESET** Acknowledges faults and alarms.

9. **HORN RESET** Deactivates the horn (audible alarm).







10. **MCB ON/OFF** Opens and closes (synchronizes) the Mains circuit breaker in MAN mode (SPtM application only).

11. **GCB ON/OFF** Opens and closes (synchronizes) the Generator circuit breaker in MAN mode.





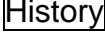

12. **ESC**











Where	Function
Measurement screens, Alarm list	Go to Menu screen
Setpoints screen	Go to Menu screen; within setpoint group, go to group list

Setpoint edit	Leave setpoint edit without changes
History screen	Go to Menu screen
FastEdit screen	Fast edit exit (to previous measurement screen) without changes
Language screen	Language screen exit (to menu) without save
Table of characters	Jump among table of characters, menu and text line

13.  Select the setpoint, setpoint group, select the screen, select history record, increase setpoint value, edit stringlist value, select language
14.  Select the setpoint, setpoint group, select the screen, select history record, decrease setpoint value, edit stringlist value, select language
15.  In AlarmList screen, shift the Alarm list page down (if more than 7 items), moves history record displayed columns to the right
16.  In AlarmList screen, shift the Alarm list page up (if more than 7 items), moves history record displayed columns to the left, go to Info screen
17.  Same as 3.
18.  Shortcut to Alarm list screen from any other screen
19.  Shortcut to History screen from any other screen

Pushbuttons' combinations

Following table determines controller functions when , , , ,  and  buttons' combination is pressed:

Where	Pushbutton combination	Function
Measurement screens, Alarm list	 +   +   + 	Contrast increase Contrast decrease Info screen
Info screen	 +   + 	Backlight increase Backlight decrease
History screen	number + 	Go to record with this number

LEDs:

20. Mains status LED
21. MCB status LED
22. Load status LED
23. GCB status LED
24. Gen-set status LED

How to select gen-set mode?

Use **MODE→** or **←MODE** to select requested gen-set operation mode OFF – MAN – **SEM** – AUT – TEST. It is not possible to go directly from OFF to AUT or TEST.

Display menus

There are several display menus (functions) available: ALARMLIST, MEASUREMENT CU, MEASUREMENT IO, SETPOINTS, HISTORY, PASSWORD and LANGUAGE.

Each menu consists of several screens.

Pressing the **ESC** (repeatedly when necessary) button the menu screen will be displayed.

Hint:

IS-NT – When pressing **ESC** on the screen with characters, focus jumps from menu to bottom line and table of characters. See picture on the right.

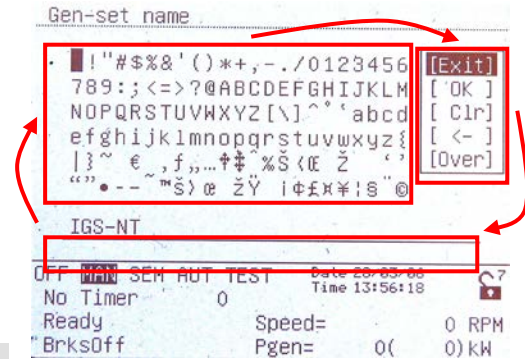

How to view Alarm list?

1. Select the ALARMLIST menu item and press **ENTER** or press **←** in measurements' screens to go directly to the Alarm list.

How to view measured data?

1. Select the MEASUREMENT CU menu item and press **ENTER**.
2. Use **↑** and **↓** to select the screen with requested data.

How to view IO values?

1. Select the MEASUREMENT IO menu item and press **ENTER**.
2. Use **↑** and **↓** to select the screen with requested data.

How to view and edit setpoints?

1. Select SETPOINTS menu item and press **ENTER**.
2. Use **↑** or **↓** to select requested set points group.
3. Press **ENTER** to confirm.
4. Use **↑** or **↓** to select requested set point.
5. Set points marked **🔒** are password protected.
6. Press **ENTER** to edit.
7. Use **↑** or **↓** to modify the set point. When **↑** or **↓** is pressed for 2 sec, auto repeat function and speedup is activated. Use **←** or **→** to change the setpoint value by 5% of it's range.
8. Press **ENTER** to confirm or **ESC** to leave without change.
9. Press **ESC** to leave selected set points group.

How to view the HISTORY menu?

1. Select HISTORY menu item and press **ENTER**
2. Use **↑** or **↓** to select a requested record.
3. Use **→** or **←** to cycle forward/backward through columns of the record.

4. Press **±** to cycle through the whole screens of columns/rows.

How to change password?

1. Select USERS/PASSWORD menu item and press **ENTER**.
2. Use **↑** or **↓** to select User.
3. Press **ENTER** to confirm.
4. Select ChangePassword and press **ENTER**
5. Use **↑** or **↓** or **←** or **→** to set new password
6. Press **ENTER** to confirm password

How to set Language?

1. Select LANGUAGE menu item (if not already selected) and press **ENTER**
2. Use **↑** or **↓** to select a requested Language.
3. Press **ENTER** to confirm.

Hint:

If binary inputs *Lang sel int A,B,C* (for IG-NT/EE internal display and IS-Display with address 1) or *Lang sel #2 A,B,C* (for IG-Display and **IS-Display with address 2**) or *Lang sel #3 A,B,C* (for **IS-Display with address 3**) are used, it is **not** possible to change languages from Language screen.

Language	0	1	2	3	4	5	6	7
Lang sel xxx A	0	1	0	1	0	1	0	1
Lang sel xxx B	0	0	1	1	0	0	1	1
Lang sel xxx C	0	0	0	0	1	1	1	1

How to change the display contrast?

Press and hold **ENTER** and use **↑** or **↓** to adjust the best display contrast.

Hint:

Available from the MEASUREMENT screens only.

How to check the serial number and software revision?

Hold down the **ENTER** and then press **ESC**. On the display you can see controller INFO screen for 10 seconds.

InteliGen ^{NT}	InteliSys ^{NT}
Controller INFO screen contains: <ol style="list-style-type: none"> 1. Controller name (see Basic settings group) 2. Controller serial number (8 character number), SW version, ID string and release date 3. Application: SPTM, SPI, COX... Using → you can view the INFO2 screen which contains: <ol style="list-style-type: none"> 1. Display SW version 2. ID chip and Dongle content 3. Password decoding string 	Controller INFO screen contains: <ol style="list-style-type: none"> 1. Controller name (see Basic settings group) 2. Firmware and release date 3. Controller serial number (8 character number) 4. Application: SPTM, SPI, COX... 5. Password decode number 6. IS-Display version and release date 7. Encoding: available character sets Using → you can view the INFO2 screen which contains:

	<ol style="list-style-type: none"> 1. IDch: ID string 2. Dngl: connected dongle 3. Supported code pages Using <input type="button" value="→"/> again you can view the INFO3 screen which contains: <ol style="list-style-type: none"> 1. IS-Display IDchip: ID string
--	-----------------------------------------------------------------------------------------------------------------------------------------------------------------------------------------------------------------------------------------------------------------------------------------------------------------------

Hint:

Available from the MEASUREMENT screens only.

How to view Connection screen on IG-Display?

Press button when in Info screen to see information about IG-Display hardware version and properties and actual state of communication with the master controller.

How to change the display backlight intensity?

Hold down the and then press . On the display you can see Controller INFO screen for 10 seconds.

Press and hold when in INFO screen and use or to adjust the best display backlight.

Backlight intensity is set for one of the two modes, depending on the activity of configurable binary input *Alt brightness* (IG-NT/EE and modifications). For IG-Display and IS-Display modules, this binary input is located in the Power connector and it's function is fixed (not configurable).

IS-Display with address 1 reads analog input *LCD brightness* on IS-NT-BB and changes accordingly display backlight intensity in the range 0-100%.

Hint:

Backlight intensity change available from the MEASUREMENT screens only.

How to find active alarms?

Select Alarmlist menu item and press or press in MEASUREMENT IO or MEASUREMENT CU menu.

Inverted alarms are still active. Non-inverted alarms are not active, but not yet confirmed.

Press to accept all alarms (an asterix mark disappears when an alarm is accepted by). Non-active alarms immediately disappear from the list.

Active alarm list appears on the screen automatically when a new alarm comes up and Main MEASUREMENT screen was selected.

Hint:

Alarm list does not activate automatically if the display is switched to any other screen than the first one of MEASUREMENT (typically the screen that shows menu selector on the upper). The automatic jump to the alarm list screen will not occur if you are listing through the measured values, set points or history!

If setpoint **Engine protect:ResetActAlarms** is set to DISABLED, only inactive alarms can be reset.
 If an active alarm is present in the alarm list, controller display blinks every 30 seconds.

When to use **GCB ON/OFF** button?

The button is disabled in AUT mode.

In MAN and TEST modes it is enabled, but before closing of the circuit breaker, generator voltage and frequency must be within limits. The controller has internal protection to avoid the breaker closure without synchronizing.

The controller recognizes automatically:

- if there is mains / bus voltage and the gen-set shall be synchronized before closing the GCB
- or if there is no voltage on the bus and the GCB can be closed without synchronizing.

When to use **MCB ON/OFF** button?

The button is disabled in AUT mode.

Use this button in MAN or TEST mode to close or open the MCB. **Be careful while doing this, because you can disconnect the load from the mains!!!**

Description of IntelliGen^{NT} MEASUREMENT screens

Main measure screen

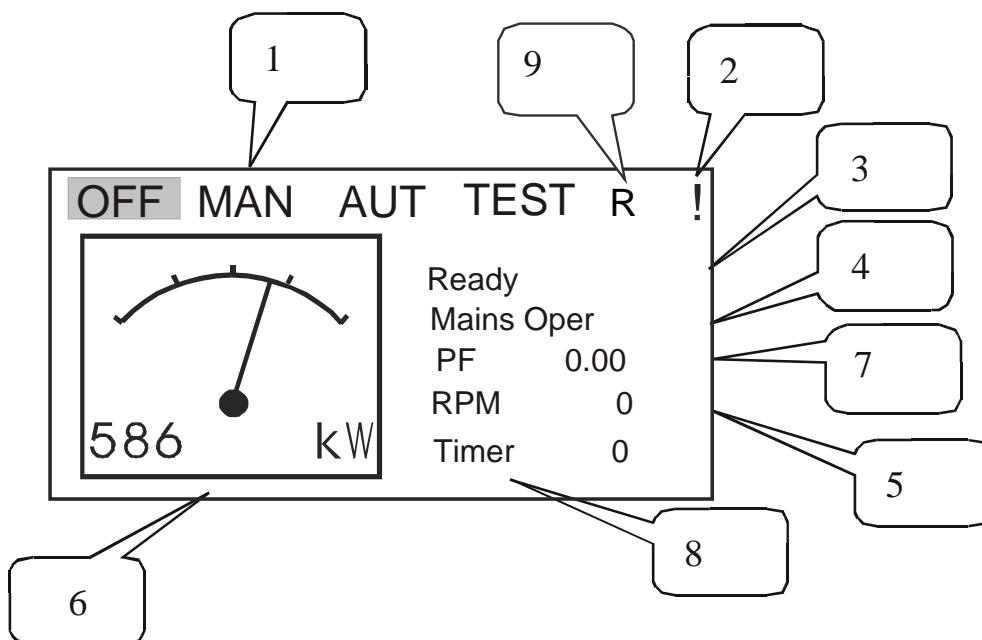

1. Operation mode of the gen-set
2. Indication of active alarm
3. Status of the gen-set

4. Actual electric condition
5. RPM of the gen-set
6. Active power
7. Power factor
8. Timer – event's counting time (e.g. prestart, cooling, ...)
9. Signalizes, when any remote connection to controller is active

Following table contains an example of MINT and SPtM MEASUREMENT screens. Other applications can be slightly different.

Measurement CU

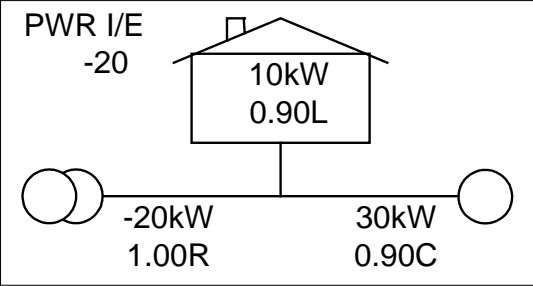
MINT	SPtM
	<p>Total power screen</p>  <p>Left up corner: Actual power control mode None or Base or Imp/Exp and required power values.</p> <p>Load: Actual value of active power. Actual value of PF</p> <p>Mains: Actual value of active power. Actual value of PF</p> <p>Gen-set: Actual value of active power. Actual value of PF</p>
<p>Generator (frequency, voltage) Gen freq Gen V1, V2, V3 ph-N (triple bargraph) Gen V12, V23, V31 ph-ph (triple bargraph)</p>	<p>Generator (frequency, voltage) Gen freq Gen V1, V2, V3 ph-N (triple bargraph) Gen V12, V23, V31 ph-ph(triple bargraph)</p>
<p>Generator (current) Gen I1, I2, I3 (triple bargraph)</p>	<p>Generator (current) Gen I1, I2, I3 (triple bargraph)</p>
<p>Bus (frequency, voltage) Bus freq Bus V1, V2, V3 ph-N (triple bargraph) Bus V12, V23, V31 ph-ph (triple bargraph)</p>	<p>Mains (frequency, voltage) Mains freq Mains V1, V2, V3 ph-N (triple bargraph) Mains V12, V23, V31 ph-ph (triple bargraph)</p>
<p>Bus (current) Im3/EarthFC (single bargraph)</p>	<p>Mains (current, power, PF) Im3/EarthFC (single bargraph)</p>

	P mains Q mains Mains PF MaxVectorS
Gen-set power Active power (total and per phase) Power factor (total and per phase) Reactive power kVAr (total and per phase) Apparent power (total and per phase)	Gen-set power Active power (total and per phase) Power factor (total and per phase) Reactive power kVAr (total and per phase) Apparent power (total and per phase)
IG-CU Analog inputs Battery voltage (single barograph) CPU temp (single barograph) Dplus (single barograph)	IG-CU Analog inputs Battery voltage (single barograph) CPU temp (single barograph) Dplus (single barograph)
Synchroscope Slip frequency Synchroscope V1g Generator first phase voltage V1b Bus first phase voltage SRO Speed regulator output indication in the range 0 to $\pm 10,00V$ VRO Voltage regulator output indication in the range 0 to 100%.	Synchroscope Slip frequency Synchroscope V1g Generator first phase voltage V1m Mains first phase voltage SRO Speed regulator output indication in the range 0 to $\pm 10,00V$ VRO Voltage regulator output indication in the range 0 to 100%.
Statistic Run hours Number of starts Number of unsuccessful starts Service time 1 Service time 2 Service time 3 Service time 4	Statistic Run hours Number of starts Number of unsuccessful starts Service time 1 Service time 2 Service time 3 Service time 4
Statistic kWhours kVARhours Time Date	Statistic kWhours kVARhours Time Date
Power management Engine priority Total running actual power Actual reserve (single barograph) CAN16 CAN32	

Measurement IO

IG-CU analog inputs AI1 to AI3	IG-CU analog inputs AI1 to AI3
-----------------------------------	-----------------------------------



+ inputs/outputs of connected ECU and/or modules, depending on actual configuration.

Description of IntelliSys^{NT} MEASUREMENT screens

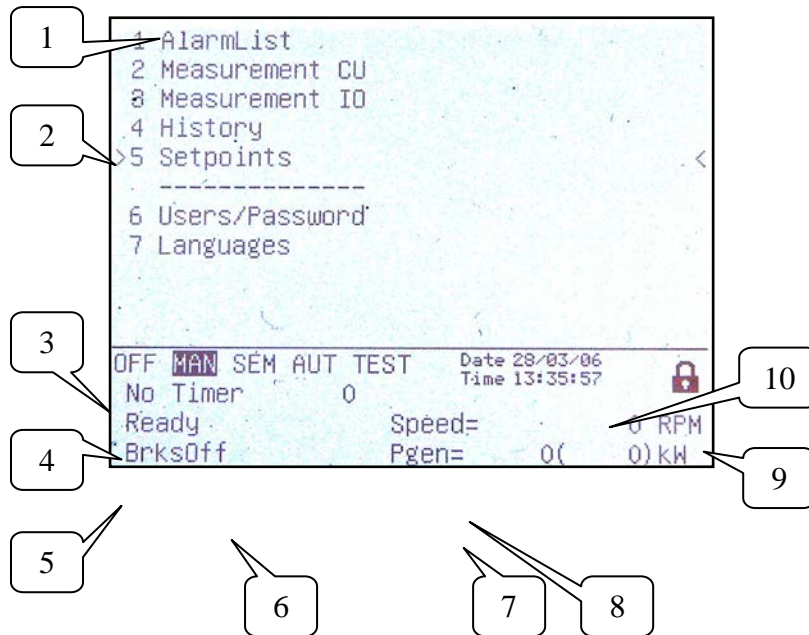
Main menu screen



1. Selection of alarm list, measurement, history, setpoints, languages or user screen.
2. Cursor shows actual selection.
3. Controller mode indication. Black background indicates active mode (MAN mode in the above example).
4. Timer – events counting time (e.g. prestart, cooling).
5. Engine machine state indication.
6. Electric machine state indication.
7. Actual gen-set power (requested gen-set power).
8. Actual RPM.
9. Indication of access level from the controller panel:

	Closed lock	No password set
	Opened lock	Password is set. Password level is visible in opened lock.

10. Controller date and time. Can be set in **Date/Time** group of setpoints.

Alarm list

	<ol style="list-style-type: none"> 1. Details of the alarm from ECU indicated by the cursor are displayed at the bottom line (SPN, FMI, OC numbers) 2. Asterisk indicates not accepted alarms (Fault reset has not been performed) 3. Alarms displayed inverted are active 4. Number of active / not accepted / all alarms
--	----------------------------------------------------------------------------------------------------------------------------------------------------------------------------------------------------------------------------------------------------------------------------------------------------------------------------------------------------------------------

Measurement CU

SPtM Screens	Description
	<ol style="list-style-type: none"> 1. Remote communication indication and access lock indication (symbol is visible when Access lock BI is active). 2. Actual gen-set power. 3. Measure screen address. For jump to this screen set this number from the numeric keypad. 4. Actual engine RPM. 5. Actual power factor.
	<ol style="list-style-type: none"> 1. Power control mode (Island / BaseLd / BldEmLm / Pwrl/E / TbyPwr) 2. PF control mode (Island / BasePF / PF I/E) 3. Required power value 4. Required PF value 5. Actual Mains active power and PF values 6. Actual load active power and PF values 7. Actual gen-set active power and PF values

<p>03/08</p> <p>1 Gen freq 0.0 Hz</p> <p>2 Gen V Ph-Ph 0 0 0 V</p> <p>3 Gen V Ph-N 0 0 0 V</p> <p>4 Gen current 0 0 0 A</p> <p>OFF MAN SEM AUT TEST Date 28/03/06 No Timer 0 Time 11:05:53</p> <p>Ready Speed= 0 RPM BrksOff Pgen= 0(0) kW</p>	<ol style="list-style-type: none"> 1. Generator frequency 2. Generator voltage phase-phase 3. Generator voltage phase-neutral + triple bargraph 4. Generator current + triple bargraph
<p>04/08</p> <p>1 Mains freq 50.0 Hz</p> <p>2 Mains V Ph-Ph 0 0 0 V</p> <p>3 Mains V Ph-N 228 227 228 V</p> <p>4 Im3/EarthFC 1 A</p> <p>5 MaxVectors 0.0 °</p> <p>OFF MAN SEM AUT TEST Date 28/03/06 No Timer 0 Time 11:06:15</p> <p>Ready Speed= 0 RPM BrksOff Pgen= 0(0) kW</p>	<ol style="list-style-type: none"> 1. Mains frequency 2. Mains voltage phase-phase 3. Mains voltage phase-neutral + triple bargraph 4. Mains current (3rd phase)/ Earth fault current 5. Maximal vector shift
<p>05/08</p> <p>1 Act power 0 kW</p> <p>2 Pwr factor 0.00</p> <p>3 React power 0.00 0.00 0.00 kVAR</p> <p>4 Appar pwr 0 0 0 kVA</p> <p>OFF MAN SEM AUT TEST Date 28/03/06 No Timer 0 Time 11:06:40</p> <p>Ready Speed= 0 RPM BrksOff Pgen= 0(0) kW</p>	<ol style="list-style-type: none"> 1. Active power (total and per phase) 2. Power factor (total and per phase) 3. Reactive power (total and per phase) 4. Apparent power (total and per phase)

<p>06/08</p> <p>1 Ubat 22.5 V</p> <p>2 CPU temp 39.5 °C</p> <p>3 Dp.lus 0.0 V</p> <hr/> <p>OFF MAN SEM AUT TEST Date 28/03/06 No Timer 0 Time 13:23:50</p> <p>Ready Speed= 0 RPM BrksOff Pgen= 0(0) KW</p>	<ol style="list-style-type: none"> 1. Battery voltage 2. CPU temperature 3. D+ voltage
<p>07/08</p> <p>1 2 Slip freq 49.98 Hz</p> <p>3 Angle #####</p> <p>4 Gen V 0 V</p> <p>5 Mains V 227 V</p> <p>6 Volt match 123</p> <p>7 000</p> <p>8 SpdRegOut 0.000 V</p> <p>VoltRegOut 0.0 %</p> <hr/> <p>OFF MAN SEM AUT TEST Date 28/03/06 No Timer 0 Time 13:24:16</p> <p>Ready Speed= 0 RPM BrksOff Pgen= 0(0) KW</p>	<ol style="list-style-type: none"> 1. Synchroscope 2. Slip frequency 3. Actual angle between generator and mains voltage 4. Generator first phase voltage 5. Mains first phase voltage 6. Voltage match of all three phases (0 – doesn't match; 1 – OK) 7. SRO – Speed Regulator Output indication in the range SpeedGovLowLim – SpeedGovHiLim 8. VRO – Voltage Regulator Output indication in the range 0 – 100%
<p>08/08</p> <p>1 Run hours 1469 h</p> <p>2 Num starts 253</p> <p>3 NumUnscStarts 53</p> <p>4 Service time 1 400 h</p> <p>5 Service time 2 800 h</p> <p>6 Service time 3 65534 h</p> <p>Service time 4 65534 h</p> <p>kWhours 1256</p> <p>kVARhours 1658</p> <hr/> <p>OFF MAN SEM AUT TEST Date 28/03/06 No Timer 0 Time 13:54:53</p> <p>Ready Speed= 0 RPM BrksOff Pgen= 0(0) KW</p>	<p>Statistics</p> <ol style="list-style-type: none"> 1. Total engine running hours 2. Total number of starts 3. Total number of unsuccessful starts 4. Service times (set in Engine protect group of setpoints) 5. Total gen-set kW hours 6. Total gen-set kVAR hours <p>Note: Statistics can be set in IntelliMonitor → Set statistics... after password of User 0 is entered.</p>

Measurement IO

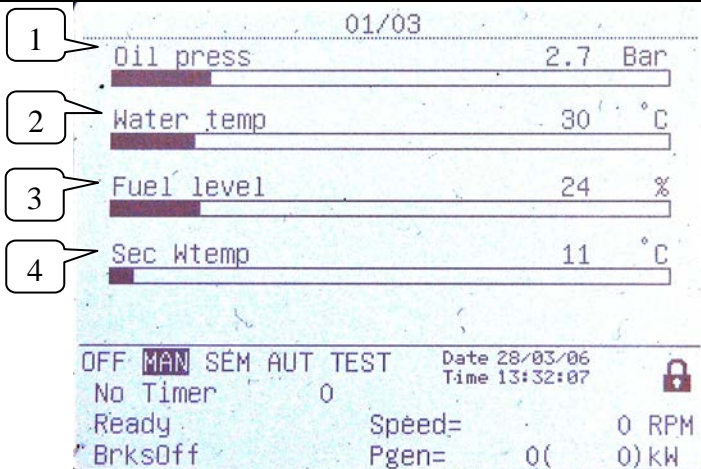
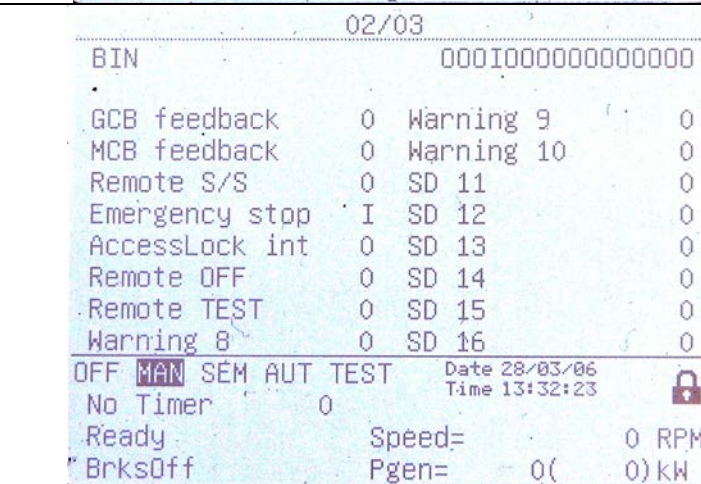
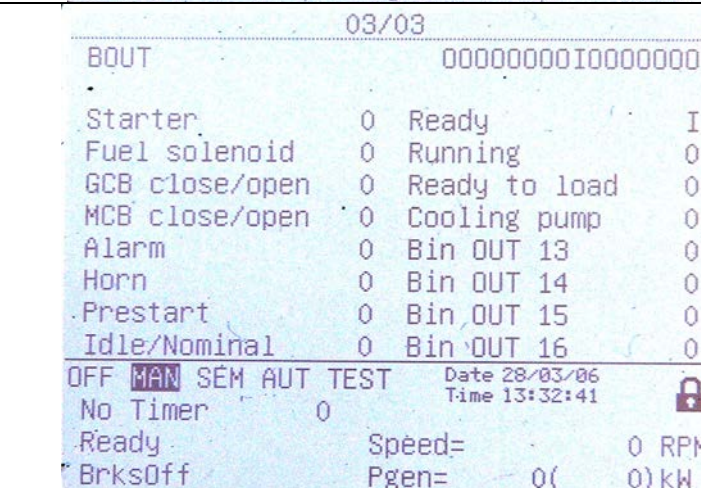
SPTM Screens	Description
 <p>01/03</p> <p>Oil press 2.7 Bar</p> <p>Water temp 30 °C</p> <p>Fuel level 24 %</p> <p>Sec Wtemp 11 °C</p> <p>OFF MAN SEM AUT TEST Date 28/03/06 Time 13:32:07</p> <p>No Timer 0</p> <p>Ready Speed= 0 RPM</p> <p>* BrksOff Pgen= 0(0) kW</p>	<p>IS-NT analog inputs</p> <ol style="list-style-type: none"> 1. Analog input 1 (e.g. Oil pressure) 2. Analog input 2 (e.g. Primary water temperature) 3. Analog input 3 (e.g. Fuel level) 4. analog input 4 (e.g. Secondary water temperature)
 <p>02/03</p> <p>BIN 0001000000000000</p> <p>GCB feedback 0 Warning 9 0</p> <p>MCB feedback 0 Warning 10 0</p> <p>Remote S/S 0 SD 11 0</p> <p>Emergency stop I SD 12 0</p> <p>AccessLock int 0 SD 13 0</p> <p>Remote OFF 0 SD 14 0</p> <p>Remote TEST 0 SD 15 0</p> <p>Warning B 0 SD 16 0</p> <p>OFF MAN SEM AUT TEST Date 28/03/06 Time 13:32:23</p> <p>No Timer 0</p> <p>Ready Speed= 0 RPM</p> <p>* BrksOff Pgen= 0(0) kW</p>	<p>IS-NT binary inputs indication</p>
 <p>03/03</p> <p>BOUT 0000000010000000</p> <p>Starter 0 Ready I</p> <p>Fuel solenoid 0 Running 0</p> <p>GCB close/open 0 Ready to load 0</p> <p>MCB close/open 0 Cooling pump 0</p> <p>Alarm 0 Bin OUT 13 0</p> <p>Horn 0 Bin OUT 14 0</p> <p>Prestart 0 Bin OUT 15 0</p> <p>Idle/Nominal 0 Bin OUT 16 0</p> <p>OFF MAN SEM AUT TEST Date 28/03/06 Time 13:32:41</p> <p>No Timer 0</p> <p>Ready Speed= 0 RPM</p> <p>* BrksOff Pgen= 0(0) kW</p>	<p>IS-NT binary outputs indication</p>

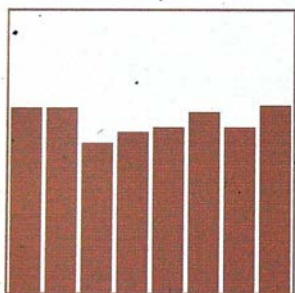
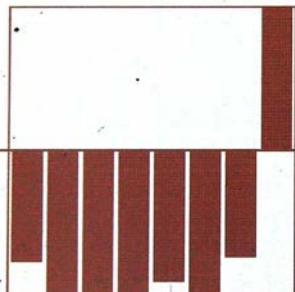
<p style="text-align: center;">05/06</p>  <p style="text-align: right;">165.7- 165.7- 133.7- 144.5- 147.7- 162.0- 148.2- 166.4-</p> <p>OFF MAN SEM AUT TEST 04/04/06 ! 🔒 No Timer 0 09:55:16 NotReady Speed= 0 RPM * MainsOper Pgen= 0(0) KW</p>	<p>If the temperatures of cylinders are configured/measured it is possible to see bargraphs of these temperatures on the separate screen.</p>
<p style="text-align: center;">06/06</p>  <p style="text-align: right;">-19.7- -51.7- -40.9- -37.7- -23.3- -37.2- -19.1- 229.8-</p> <p>OFF MAN SEM AUT TEST 04/04/06 🔒 No Timer 0 09:56:21 NotReady Speed= 0 RPM * MainsOper Pgen= 0(0) KW</p>	<p>Another screen shows the differences of cylinder temperatures from the average temperature.</p>
<p>Further screens are automatically added if I/O extension modules or ECU are connected to the controller.</p>	

History

<table border="1"> <thead> <tr> <th>No.</th> <th>Reason</th> <th>Time</th> <th>Date</th> </tr> </thead> <tbody> <tr><td>0</td><td>Wrn Warnins 8</td><td>13:25:13.8</td><td>28/03/2006</td></tr> <tr><td>-1</td><td>Sd SD 12</td><td>13:25:06.4</td><td>28/03/2006</td></tr> <tr><td>-2</td><td>Not ready</td><td>13:25:02.4</td><td>28/03/2006</td></tr> <tr><td>-3</td><td>Sd SD 11</td><td>13:25:02.4</td><td>28/03/2006</td></tr> <tr><td>-4</td><td>Wrn Warnins 9</td><td>13:25:00.9</td><td>28/03/2006</td></tr> <tr><td>-5</td><td>Terminal</td><td>13:07:16.8</td><td>28/03/2006</td></tr> <tr><td>-6</td><td>Ready</td><td>13:07:16.8</td><td>28/03/2006</td></tr> <tr><td>-7</td><td>Switched On</td><td>13:07:15.5</td><td>28/03/2006</td></tr> <tr><td>-8</td><td>Ready</td><td>13:07:06.3</td><td>28/03/2006</td></tr> <tr><td>-9</td><td>Fault reset</td><td>13:07:06.3</td><td>28/03/2006</td></tr> <tr><td>-10</td><td>Not ready</td><td>11:50:59.3</td><td>28/03/2006</td></tr> <tr><td>-11</td><td>Start fail</td><td>11:50:57.2</td><td>28/03/2006</td></tr> <tr><td>-12</td><td>Gen start</td><td>11:49:39.2</td><td>28/03/2006</td></tr> <tr><td>-13</td><td>Terminal</td><td>10:50:47.4</td><td>28/03/2006</td></tr> <tr><td>-14</td><td>Ready</td><td>10:50:47.3</td><td>28/03/2006</td></tr> <tr><td>-15</td><td>Switched On</td><td>10:50:46.1</td><td>28/03/2006</td></tr> <tr><td>-16</td><td>Ready</td><td>10:45:33.0</td><td>28/03/2006</td></tr> <tr><td>-17</td><td>Fault reset</td><td>10:45:33.0</td><td>28/03/2006</td></tr> <tr><td>-18</td><td>Not ready</td><td>10:45:29.1</td><td>28/03/2006</td></tr> <tr><td>-19</td><td>Start fail</td><td>10:45:27.0</td><td>28/03/2006</td></tr> <tr><td>-20</td><td>Gen start</td><td>10:44:53.7</td><td>28/03/2006</td></tr> <tr><td>-21</td><td>Terminal</td><td>10:37:24.5</td><td>28/03/2006</td></tr> <tr><td>-22</td><td>Ready</td><td>10:37:24.4</td><td>28/03/2006</td></tr> </tbody> </table> <p>No. 0 Date 28/03/2006 Reason Wrn Warn Time 13:25:13.8</p>	No.	Reason	Time	Date	0	Wrn Warnins 8	13:25:13.8	28/03/2006	-1	Sd SD 12	13:25:06.4	28/03/2006	-2	Not ready	13:25:02.4	28/03/2006	-3	Sd SD 11	13:25:02.4	28/03/2006	-4	Wrn Warnins 9	13:25:00.9	28/03/2006	-5	Terminal	13:07:16.8	28/03/2006	-6	Ready	13:07:16.8	28/03/2006	-7	Switched On	13:07:15.5	28/03/2006	-8	Ready	13:07:06.3	28/03/2006	-9	Fault reset	13:07:06.3	28/03/2006	-10	Not ready	11:50:59.3	28/03/2006	-11	Start fail	11:50:57.2	28/03/2006	-12	Gen start	11:49:39.2	28/03/2006	-13	Terminal	10:50:47.4	28/03/2006	-14	Ready	10:50:47.3	28/03/2006	-15	Switched On	10:50:46.1	28/03/2006	-16	Ready	10:45:33.0	28/03/2006	-17	Fault reset	10:45:33.0	28/03/2006	-18	Not ready	10:45:29.1	28/03/2006	-19	Start fail	10:45:27.0	28/03/2006	-20	Gen start	10:44:53.7	28/03/2006	-21	Terminal	10:37:24.5	28/03/2006	-22	Ready	10:37:24.4	28/03/2006	<p>1. Bottom lines show record number, reason, date and time even if other columns are actually displayed</p>
No.	Reason	Time	Date																																																																																														
0	Wrn Warnins 8	13:25:13.8	28/03/2006																																																																																														
-1	Sd SD 12	13:25:06.4	28/03/2006																																																																																														
-2	Not ready	13:25:02.4	28/03/2006																																																																																														
-3	Sd SD 11	13:25:02.4	28/03/2006																																																																																														
-4	Wrn Warnins 9	13:25:00.9	28/03/2006																																																																																														
-5	Terminal	13:07:16.8	28/03/2006																																																																																														
-6	Ready	13:07:16.8	28/03/2006																																																																																														
-7	Switched On	13:07:15.5	28/03/2006																																																																																														
-8	Ready	13:07:06.3	28/03/2006																																																																																														
-9	Fault reset	13:07:06.3	28/03/2006																																																																																														
-10	Not ready	11:50:59.3	28/03/2006																																																																																														
-11	Start fail	11:50:57.2	28/03/2006																																																																																														
-12	Gen start	11:49:39.2	28/03/2006																																																																																														
-13	Terminal	10:50:47.4	28/03/2006																																																																																														
-14	Ready	10:50:47.3	28/03/2006																																																																																														
-15	Switched On	10:50:46.1	28/03/2006																																																																																														
-16	Ready	10:45:33.0	28/03/2006																																																																																														
-17	Fault reset	10:45:33.0	28/03/2006																																																																																														
-18	Not ready	10:45:29.1	28/03/2006																																																																																														
-19	Start fail	10:45:27.0	28/03/2006																																																																																														
-20	Gen start	10:44:53.7	28/03/2006																																																																																														
-21	Terminal	10:37:24.5	28/03/2006																																																																																														
-22	Ready	10:37:24.4	28/03/2006																																																																																														

Users/Password

<pre>>0 - U0 1 - John 2 - Peter 3 - George 4 - ----- 5 - ----- 6 - ----- 7 - -----</pre> <p>OFF MAN SEM AUT TEST Date 28/03/06 No Timer 0 Time 13:53:09 </p> <p>Ready Speed= 0 RPM BrksOff Pgen= 0(0)kW</p>	<p>This screen shows list of users. To enter or change password of selected user press Enter.</p>
-------------------------------------------------------------------------------------------------------------------------------------------------------------------------------------------------------------------------------------------------------------------------------------------------------------------------------------------------------------------------------------------------------------------------------------------------------------------------	-------------------------------------------------------------------------------------------------------

Users and Passwords

Up to 8 users can be defined in the system. Every user has its own defined level of access rights. There are seven levels of password protection.

User 0 – Administrator has always level 7.

Hint:

The lock mark  appears before a set point name (on controller screen) if the setpoint is password protected.

The lock mark is removed only when the password is set from controller's front panel.



The lock mark is still visible on controller screen even if the password is set from different terminal.

Even though one level may have been set from the front panel, the affected set points are not accessible from IntelliMonitor (direct or Modem) until this level is set in IntelliMonitor (direct or Modem). Set point screen opened from front panel is automatically closed 15 minutes after the last key has been pressed.

It is possible to protect remote Start, Stop, GCB and MCB commands from IntelliMonitor. This seven level command protection can be configured in GenConfig.

EnterPassword

Password is a five-digit number (0 - 65535). Only setpoints associated with the entered password level can be modified.

Use  or  to select the desired password and then press **ENTER**.

Use  or  to move the value by 5% of the range.

Mode and function description

There are four gen-set operation modes: OFF - MAN – AUT – TEST in SPtM application. There are three gen-set operation modes: OFF - MAN – AUT in SPI, COX and MINT application.

To select the mode use **MODE→** or **←MODE**.

OFF mode

- No start of the gen-set is possible. Outputs STARTER, GCB CLOSE/OPEN and FUEL SOLENOID are not energized.
- No reaction if buttons **START**, **STOP**, **GCB ON/OFF** are pressed.
- MCB behavior depends on **AMF settings**: *MCB opens on setpoint*:
 - MAINSFAIL: When power-cut comes, MCB opens. After Mains returns, MCB closes with *MCB close del*.
 - GEN RUNNING: When power-cut comes, MCB stays closed until the gen-set starts and produces voltage within limits.

MAN mode

- 1) To start the gen-set press **START**.
- 2) When the generator voltage is within limits (adjusted in the setpoints group **Generator protections**) GCB green LED on the front panel lights.
- 3) Press **GCB ON/OFF** to close the GCB. If the generator voltage is out of the limits, controller does not respond to the **GCB ON/OFF**.
 - a) If controller detects dead bus, immediately closes GCB OPEN/CLOSE output.
 - b) If controller detects voltage on the bus, starts synchronizing.
- 4) To stop the engine press **STOP**
 - a) controller unloads the gen-set, opens GCB CLOSE/OPEN. Unloading is active only when binary input MCB feedback is closed or other gen-set is connected to bus. In other case GCB CLOSE/OPEN opens immediately.
 - b) Gen-set is cooled down and stopped.

Hint:

Controller does not respond to external signals and/or conditions. The gen-set is fully in manual control; there is no automatic way to stop it (except protections). The gen-set stays running until STOP button is pressed.

Controller does not take place in Power management in MINT application

AUT mode

Gen-set is controlled based on external signals (Rem start/stop, Sys start/stop) or conditions (AMF, Peak shaving, Power management system, ...).

Hint:

Engine does not stop, if other condition for automatic starts is active.

Example: If peak stop condition occurs, but REMOTE START/STOP is active, engine stays running.

Controller does not respond to **GCB ON/OFF** , **MCB ON/OFF**, **STOP**, **START** buttons and corresponding remote IntelliMonitor or Modbus commands.

Set **Basic setting**: *FltRes GoToMAN* = ENABLED to avoid automatic engine start

!!!! VERY IMPORTANT !!!!

when pressing **FAULT RESET** after Shut down or Slow stop alarm.

Engine can start automatically without warning when pressing **FAULT RESET** after shut down alarm.

TEST mode (SPtM only)

Use TEST mode for Gen-set start test if the Mains is OK or to transfer the load to the gen-set when Mains fail is announced in advance.

Hint:

The controller does not respond to **GCB ON/OFF** , **STOP**, **START** in *Ret from test = AUTO*.

Engine automatically starts, when TEST mode is selected.

Engine can start automatically without warning when pressing **FAULT RESET** after shut down alarm.

SEM mode

START – starts the gen-set.

- The controller closes GCB to dead bus.
- If the Mains is within limits and MCB is closed, the controller starts synchronizing and closes GCB when synchronizing conditions are met. Gen-set remains running in parallel.
- If Mains failure is recognized during parallel operation the controller opens MCB.
- After Mains recovers the controller synchronizes MCB and returns to parallel operation

STOP – unloads the gen-set, opens GCB, cools down the engine and stops.

AMF function – If the Mains fails while the gen-set is not running, the controller automatically starts and closes GCB.

Other automatic starts/stops (e.g. due to peak shaving, BI Rem start/stop activation) are not performed in SEM mode.

Baseload

Process control: *Load ctrl PtM* = BASELOAD

Gen-set power is kept at value given by **Process control**: *Base load* setpoint.

Internal Import export

ProcessControl: *Load ctrl PtM* = IMP/EXP

Process control: *IE measurement* = IM3 CT INPUT

Gen-set power is controlled to keep the import load at the level given by setpoint

Process control: *Import load* value.

Controller measures Import/Export value via current transformers connected to In/Im3 terminal. The value of L3 is then multiplied by 3 to give an estimation of the actual Imp/Exp.

List of abbreviations

AI	Analog Input
AMF	Auto Mains Failure (controller starts automatically on mains failure)
AO	Analog Output
ATS	Automatic Transfer Switch (switches the load to actually supplied bus (by mains or generators))
AVR	Automatic Voltage Regulator
BI	Binary Input
BO	Binary Output
BOC	Breaker Open & Cool-down - protection type (see application manual for details)
BTB	Bus-Tie Breaker
CAN1	CAN bus for extension modules connection (e.g. IGS-PTM, IS-BIN8/16, IS-AIN8, I-AOUT8, I-CB, IGL-RA15)
CAN2	CAN bus for intercontroller communication (in multiple applications) and monitoring (connection of I-LB, IG-IB)
Combi	Application where SPTM, SPI or MINT can be used. Application is defined by Binary inputs combination.
COX	Application for Complex Systems where actions are taken by a PLC and the controller only follows the orders => needs an external driver (cox)
ESF	Engine Specific File
FMI	Failure Mode Identifier
GC	Graphical Characters - option for additional support of one "graphical" language
GCB	Generator Circuit Breaker
CHP	Combined Heat & Power - cogeneration application, usually with gas engine
I-AOUT8	Extension module with 8 AO
I-CB	Communication Bridge - interfaces IS, IG/IS-NT, ID controllers and non-standard engine ECU
IG-AVRi	IG Automatic Voltage Regulator interface
IG-EE	InteliGen for Electronic Engines (HW optimized for connection to an engine equipped with ECU)
IG-EEC	InteliGen EE controller with extended communication possibilities + switchable sensing ranges of AC voltages and currents
IG-IB	IG Internet Bridge - for internet/ethernet communication
IGL-RA15	Indication panel with LEDs signaling state of 15 BO
IG-NT	InteliGen New Technology gen-set controller

IG-NT-BB	InteliGen New Technology Base Box gen-set controller (without display)
IG-NTC	InteliGen NT controller with extended communication possibilities + switchable sensing ranges of AC voltages and currents
IG-NTC-BB	InteliGen New Technology Base Box gen-set controller with extended communication possibilities + switchable sensing ranges of AC voltages and currents (without display)
IGS-NT-LSM+PMS	Dongle for IG-XX and IS-NT to enable Load Sharing control loops and PMS
IGS-PTM	Extension module with 8 BI/BO, 4 AI and 1 AO
I-LB	Local Bridge – for direct and modem monitoring and control of multiple gen-sets
IM-NT	InteliMains New Technology - Mains supervision controller; the same controller in a different SW configuration can work as a bus-tie synchronizer
IM-NT-BB	InteliMains New Technology – Mains supervision controller; (without display)
I-RB	Relay Board
IS-AIN8	Extension module with 8 AI.
IS-BIN8/16	Extension module with 8 BO and 16 BI.
IS-NT	InteliSys New technology gen-set controller
IS-NT	InteliSys New technology gen-set controller
IS-NT-BB	InteliSys New Technology Base Box (without display)
IS-NT-BB	InteliSys New Technology Basic Box (without display)
IS-NTC-BB	InteliSys New Technology Base Box gen-set controller with extended communication possibilities (without display)
KWP2000	Key Word Protocol of Scania S6 unit (for engine diagnostics)
LS	Load Sharing - analog load sharing line to interconnect the gen-sets on the site (for isolated parallel or mains parallel of multiple gen-sets); IG/IS-NT controllers use digital Load Sharing via CAN2 bus
LSM	Load Sharing Module
LT	Option for Low Temperature modification (display equipped with heating foil)
MCB	Mains Circuit Breaker
MGCB	Master Generator Circuit Breaker (sometimes used with multiple gen-sets in island parallel or mains parallel operation)

MINT	Multiple application with INTERNAL control loops - for multiple gen-sets in island parallel or mains parallel operation; Load Sharing and VAR Sharing controlled internally; PMS available
MP	Mains protection
NPU	Mains protection relay (voltage, frequency, vector shift protections)
OC	Occurrence Count (number of fault occurrences transmitted in diagnostic frame from ECU)
OfL	Off load - protection type (see application manual for details)
PGN	Parameter Group Number (refer to SAE J1939-71)
PMS	Power Management System - ensures optimization of running gen-sets on the site with multiple gen-sets; based on kW/kVA spinning reserve or on relative (%) load; no-master system ensures high reliability
SHAIN	Shared (virtual) Analog INput module
SHAOUT	Shared (virtual) Analog OUTput module
SHBIN	SHared (virtual) Binary INput module
SHBOUT	SHared (virtual) Binary OUTput module
SPI	Single Parallel Island application - for single gen-sets in parallel with mains or in island operation; suitable for CHP application; no MCB control
SPM	Single Prime Mover application - for single gen-sets without mains
SPN	Suspect Parameter Number (refer to SAE J1939-71)
SPtM	Single Parallel to Mains application - for single gen-sets in parallel with mains or in island operation, with AMF support; both MCB and GCB controlled
SSB	Single Stand-By application - for single gen-sets with mains and break transfer gen-set to mains
VPIO	Virtual periphery I/O module – internal “SW wires” linking binary outputs to inputs
VS	VAR Sharing - ensures VAR sharing between the gen-sets on the site via CAN bus (for isolated parallel or mains parallel of multiple gen-sets)