

MainsPro

Mains Decoupling Protection Relay

SW version 1.6.1

1 Document information	6
2 Introduction of Installation and Operation Guide	9
3 Installation data	11
4 User interface	20
5 Introduction of Application Guide	29
6 Important Steps of MainsPro utilization	31
7 TRIP and Fault Reset	32
8 Protective features	34
9 Application tips	41
10 Introduction of Reference Guide	45
11 Technical data	46
12 Appendix	51

Table of contents

1 Document information	6
1.1 Clarification of notation	6
1.2 About this guide	6
1.2.1 Installation and Operation Guide	6
1.2.2 Application Guide	6
1.2.3 Reference Guide	6
1.3 Legal notice	6
1.4 Document history	7
2 Introduction of Installation and Operation Guide	9
2.1 Purpose of this manual	9
2.2 Conformity declaration	9
2.3 Warnings	9
2.3.1 Dangerous voltage	10
2.3.2 Adjust the setpoints	10
3 Installation data	11
3.1 Dimensions	11
3.2 List of terminals	12
3.3 Wiring	12
3.3.1 “Star” connection	13
3.3.2 “Delta” connection	14
3.3.3 Connection with voltage transformers	14
3.3.4 Single-phase connection	15
3.3.5 Power supply	15
3.3.6 Relay outputs connection	16
3.3.7 Binary switches connection	17
3.4 Measurement range	17
3.5 Wiring examples	17
4 User interface	20
4.1 Front panel elements	20
4.1.1 Pushbuttons	21
4.1.2 Setpoints change	21
4.1.3 Reset operation time	22
4.1.4 Reset trip counters	22
4.1.5 TEST mode activation	22
4.1.6 Factory default	23

4.2 Mechanical sealing	23
4.3 Signalization LEDs	23
4.4 Measurement screens	25
4.5 Alarm messages	27
5 Introduction of Application Guide	29
5.1 Purpose of this manual	29
5.2 MainsPro typical usage	29
5.3 Typical applications of MainsPro protection relay	29
6 Important Steps of MainsPro utilization	31
7 TRIP and Fault Reset	32
7.1 TRIP	32
7.1.1 TRIP event	32
7.1.2 TRIP status	32
7.2 Fault reset	33
8 Protective features	34
8.1 ANSI 59 Overvoltage, ANSI 27 Undervoltage	34
8.2 Floating 10 minutes average overvoltage	35
8.3 ANSI 81H Overfrequency, 81L Underfrequency	35
8.4 ANSI 47 Voltage unbalance and angle asymmetry	37
8.4.1 Voltage unbalance	37
8.4.2 Positive sequence undervoltage, Negative sequence overvoltage	37
8.5 ANSI 78 Vector shift	38
8.5.1 Measuring principle	39
8.6 81R Rate Of Change Of Frequency (ROCOF)	40
8.7 Phase rotation, incorrect phase polarity	40
9 Application tips	41
9.1 Automatic return to mains	41
9.2 Binary switches	41
9.2.1 External trip	42
9.2.2 Fault reset	42
9.2.3 Alternative settings	42
9.2.4 Disable	42
9.2.5 CB Feedback	42
9.3 Counters	42
9.4 Timer	43
9.5 Start trip	43

9.6 TEST mode	43
10 Introduction of Reference Guide	45
10.1 Purpose of this manual	45
11 Technical data	46
11.1 Accuracies and reaction times	46
11.1.1 Operating area	46
11.1.2 Voltage measurement	47
11.1.3 Frequency measurement	47
11.1.4 Time delays accuracy	47
11.1.5 Loss of Mains reaction times	47
11.2 Technical parameters	47
11.2.1 Endurance to the power supply voltage fails	48
11.3 Factory default setting of MainsPro unit	48
12 Appendix	51
12.1 Library of Setpoints	52
12.1.1 Group: Basic	53
12.1.2 Group: V <>, A.V <>	56
12.1.3 Group: dU, A.dU	57
12.1.4 Group: f <>, A.f <>	58
12.1.5 Group: LOM, A.LOM	59
12.1.6 Group: f(BI)	60
12.1.7 Group: f(RE)	61
12.2 Library of Binary switches	62
12.2.1 Ext1	62
12.2.2 Ext2	62
12.2.3 Fault Reset	62
12.2.4 Alt Settings	62
12.2.5 Disable	62
12.2.6 CB Feedback	62
12.3 Relay outputs	63
12.3.1 CommTrpPer	64
12.3.2 !CommTrpPer	64
12.3.3 CommTrpImp	64
12.3.4 !CommTrpImp	64
12.3.5 CommSigImp	64
12.3.6 !CommSigImp	65
12.3.7 CommSigDel	65

12.3.8 !CommSigDel	65
12.3.9 U Sig	65
12.3.10 !U Sig	65
12.3.11 f Sig	66
12.3.12 !f Sig	66
12.3.13 LOM Sig	66
12.3.14 !LOM Sig	66
12.3.15 dU Sig	66
12.3.16 !dU Sig	67
12.3.17 Other Sig	67
12.3.18 !Other Sig	67
12.3.19 Alt Sig	67
12.3.20 TrpEndImp	67
12.3.21 !TrpEndImp	68
12.3.22 InternFail	68
12.3.23 !InternFail	68
12.3.24 BakTrpPer	68
12.3.25 !BakTrpPer	68
12.3.26 BakTrplmp	69
12.3.27 !BakTrplmp	69

1 Document information

1.1 Clarification of notation	6
1.2 About this guide	6
1.3 Legal notice	6
1.4 Document history	7

1.1 Clarification of notation

Note: This type of paragraph calls readers attention to a notice or related theme.

IMPORTANT: This type of paragraph highlights a procedure, adjustment etc., which can cause a damage or improper function of the equipment if not performed correctly and may not be clear at first sight.

Example: This type of paragraph contains information that is used to illustrate how a specific function works.

1.2 About this guide

1.2.1 Installation and Operation Guide

The Installation and Operation Guide serves for the personnel providing installation of the MainsPro unit. It contains wiring and setting instructions needed for installation and commissioning of the unit. It also contains introduction of the user interface and necessary procedures for setting and operation of the unit. Although MainsPro is very simple and intuitive for the operating personnel, we recommend keeping a hardcopy of this manual available permanently at the site where MainsPro unit is installed, to facilitate the necessary service and operation tasks.

1.2.2 Application Guide

The Application Guide serves for the designers and engineers who process the necessary documentation and implementation procedures on the site where MainsPro is installed. It contains detailed description of MainsPro functionalities and their practical application.

1.2.3 Reference Guide

The Reference Guide contains library of setpoints, inputs and outputs functionalities and detailed technical information. This information is referenced in the Installation and Operation Guide and Application Guide.

1.3 Legal notice

This End User's Guide/Manual as part of the Documentation is an inseparable part of ComAp's Product and may be used exclusively according to the conditions defined in the "END USER or Distributor LICENSE AGREEMENT CONDITIONS – COMAP CONTROL SYSTEMS SOFTWARE" (License Agreement) and/or in the "ComAp a.s. Global terms and conditions for sale of Products and provision of Services" (Terms) and/or in

the “Standardní podmínky projektů komplexního řešení ke smlouvě o dílo, Standard Conditions for Supply of Complete Solutions” (Conditions) as applicable.

ComAp’s License Agreement is governed by the Czech Civil Code 89/2012 Col., by the Authorship Act 121/2000 Col., by international treaties and by other relevant legal documents regulating protection of the intellectual properties (TRIPS).

The End User and/or ComAp’s Distributor shall only be permitted to use this End User’s Guide/Manual with ComAp Control System Registered Products. The Documentation is not intended and applicable for any other purpose.

Official version of the ComAp’s End User’s Guide/Manual is the version published in English. ComAp reserves the right to update this End User’s Guide/Manual at any time. ComAp does not assume any responsibility for its use outside of the scope of the Terms or the Conditions and the License Agreement.

Licensed End User is entitled to make only necessary number of copies of the End User’s Guide/Manual. Any translation of this End User’s Guide/Manual without the prior written consent of ComAp is expressly prohibited!

Even if the prior written consent from ComAp is acquired, ComAp does not take any responsibility for the content, trustworthiness and quality of any such translation. ComAp will deem a translation equal to this End User’s Guide/Manual only if it agrees to verify such translation. The terms and conditions of such verification must be agreed in the written form and in advance.

For more details relating to the Ownership, Extent of Permitted Reproductions Term of Use of the Documentation and to the Confidentiality rules please review and comply with the ComAp’s License Agreement, Terms and Conditions available on www.comap-control.com.

Security Risk Disclaimer

Pay attention to the following recommendations and measures to increase the level of security of ComAp products and services.

Please note that possible cyber-attacks cannot be fully avoided by the below mentioned recommendations and set of measures already performed by ComAp, but by following them the cyber-attacks can be considerably reduced and thereby to reduce the risk of damage. ComAp does not take any responsibility for the actions of persons responsible for cyber-attacks, nor for any damage caused by the cyber-attack. However, ComAp is prepared to provide technical support to resolve problems arising from such actions, including but not limited to restoring settings prior to the cyber-attacks, backing up data, recommending other preventive measures against any further attacks.

Warning: Some forms of technical support may be provided against payment. There is no legal or factual entitlement for technical services provided in connection to resolving problems arising from cyber-attack or other unauthorized accesses to ComAp’s Products or Services.

1.4 Document history

Revision number	Related SW	Date of issue	Author
10	1.6.1	24.5.2019	Lukáš Vančura
9	1.6.1	26.4.2019	Petra Piclová
8	1.6.0	13.3.2018	Petra Piclová
7	1.5.0	16.1.2015	Petra Piclová
6	1.4.1	15.11.2013	Petra Piclová
5	1.4.0	30.10.2013	Petra Piclová

Revision number	Related SW	Date of issue	Author
4	1.3.0	30.8.2012	Tomáš Jelen
3	1.2.0	20.4.2012	Tomáš Jelen
2	1.1.0	2.11.2011	Tomáš Jelen
1	1.0.0	18.6.2010	Tomáš Jelen

 [back to Document information](#)

2 Introduction of Installation and Operation Guide

2.1 Purpose of this manual	9
2.2 Conformity declaration	9
2.3 Warnings	9

back to Table of contents

Congratulations to your purchase of ComAp MainsPro unit! MainsPro is a microprocessor-based protective relay, providing a comprehensive set of protective and supplementary functionalities. The basic protective functions are:

- ▶ Voltage
- ▶ Frequency
- ▶ Loss of mains

This covers the basic requirements for mains-decoupling (inter-tie) protection, but allows also usage in many applications where benefits of the unit's unique functionality is needed.

2.1 Purpose of this manual

The Installation and Operation Guide serves for the personnel providing installation of the MainsPro unit. It contains wiring and setting instructions needed for installation and commissioning of the unit. It also contains introduction of the user interface and necessary procedures for setting and operation of the unit. Although MainsPro is very simple and intuitive for the operating personnel, we recommend keeping a hardcopy of this manual available permanently at the site where MainsPro unit is installed, to facilitate the necessary service and operation tasks.

2.2 Conformity declaration

Following described machine complies with the appropriate basic safety and health requirement of the EC Low Voltage Directive No: 73/23 / EEC and EC Electromagnetic Compatibility Directive 89/336 / EEC based on its design and type, as brought into circulation by us.



2.3 Warnings

IMPORTANT: Be aware that the relay outputs can change state during and after the unit setting (before the unit is used again ensure that the proper setting is done)!!!

IMPORTANT: Be aware that the devices connected to binary outputs of the unit may operate upon disconnection of power supply, measurement inputs and/or binary inputs!!!

2.3.1 Dangerous voltage

In no case touch the terminals for voltage and current measurement!

Always connect grounding terminals!

Before accessing potentially life-threatening live parts the device must be isolated or disconnected from dangerous voltage.

2.3.2 Adjust the setpoints

All parameters are adjusted to their typical values. However the setpoints have to be checked and adjusted to their required values before the first starting of the gen-set.

The following instructions are for qualified personnel only. To avoid personal injury do not perform any action not specified in related guides for product.

Note: *ComAp believes that all information provided herein is correct and reliable and reserves the right to update at any time. ComAp does not assume any responsibility for its use unless otherwise expressly undertaken.*

 [back to Introduction of Installation and Operation Guide](#)

3 Installation data

- 3.1 Dimensions 11
- 3.2 List of terminals 12
- 3.3 Wiring 12
- 3.4 Measurement range 17
- 3.5 Wiring examples 17

[🔍 back to Table of contents](#)

3.1 Dimensions

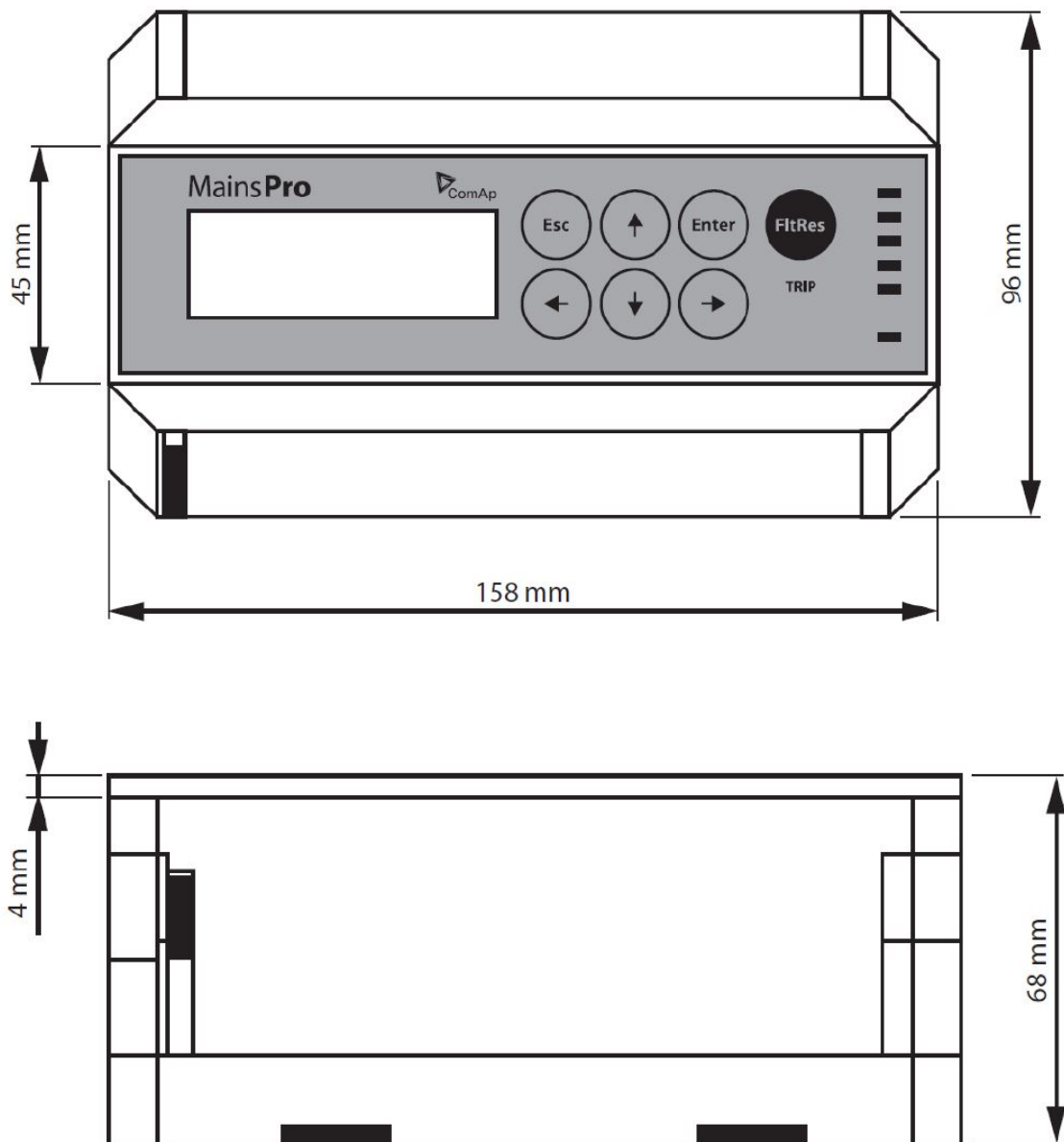

3.2 List of terminals

BIC	Binary inputs – COM terminal
BI1 – BI4	Configurable binary inputs
U _A 1 to 3	First set of voltage measurement terminals (UA). Terminals UA1 and UA2 are internally interconnected
U _B 1 to 3	Second set of voltage measurement terminals (UB). Terminals UB1 and UB2 are internally interconnected
U _C 1 to 3	Third set of voltage measurement terminals (UC). Terminals UC1 and UC2 are internally interconnected
11, 21, 31, 41, 51	RE1-5 relay contact – common
12, 22, 32, 42, 52	RE1-5 relay contact – normally closed (during fault-free conditions maintained in open position)
14, 24, 34, 44, 54	RE1-5 relay contact – normally open (during fault-free conditions maintained in closed position)
L/+	Power supply – high range 85-265 VAC / 110 – 370 VDC
+	Power supply – low range 8 – 40 VDC. Connect “+” pole to this terminal
N/-	Common terminal for power supply. In case of DC supply, connect “-“ pole to this terminal

3.3 Wiring

3.3.1 “Star” connection	13
3.3.2 “Delta” connection	14
3.3.3 Connection with voltage transformers	14
3.3.4 Single-phase connection	15
3.3.5 Power supply	15
3.3.6 Relay outputs connection	16
3.3.7 Binary switches connection	17

3.3.1 “Star” connection

If used for rated voltage 230 VAC ph-N, set the setpoint **U_{in}** (page 53) to 230 V, for systems with rated voltage 120VAC ph-N, set the setpoint **U_{in}** (page 53) is to 120V. No additional setting is necessary for indication of “Star” connection - MainsPro provides automatic detection of phase-neutral voltage measurement. MainsPro provides over-range to 130% of the rated voltage, i.e. 300 VAC for 230 V system and 156 V for 120 V system with no change of measurement accuracy.

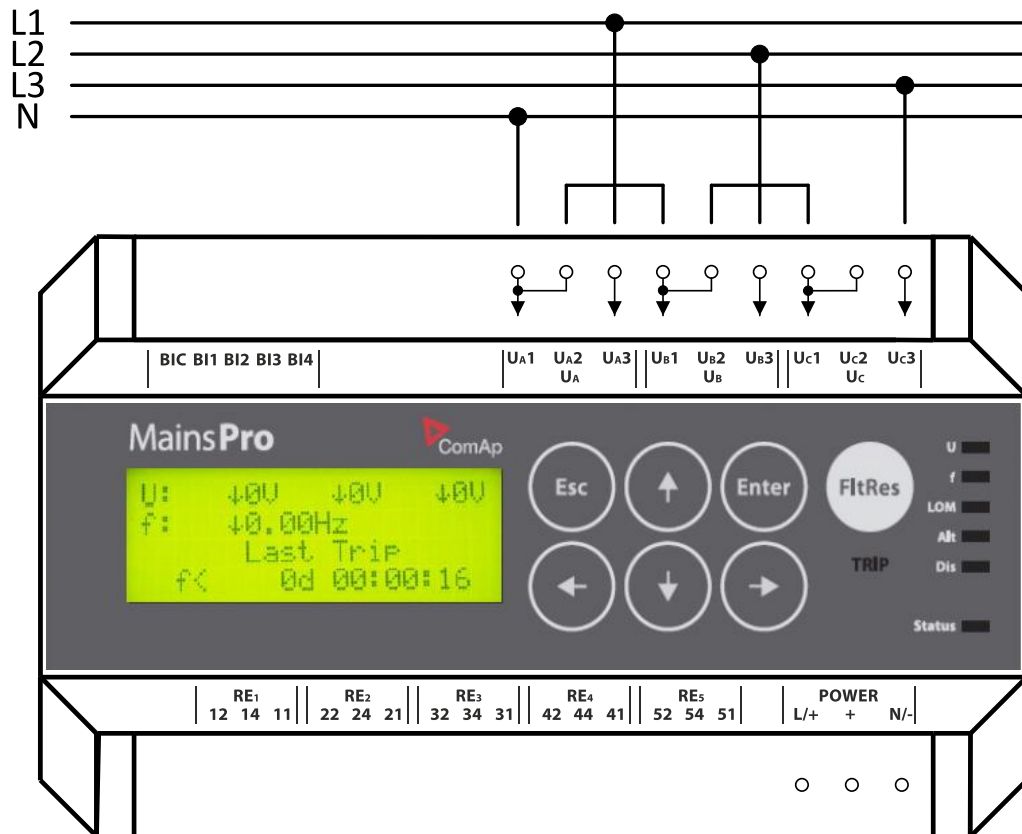

3.3.2 “Delta” connection

In this arrangement, MainsPro is rated for 400 VAC ph-ph with over-range to 130% = 520 VAC with no change of measurement accuracy. Setpoint **Uin** (page 53) is to be set to 400 V, no additional setting is necessary for indication of “Delta” connection. MainsPro provides automatic detection of phase-phase voltage measurement.

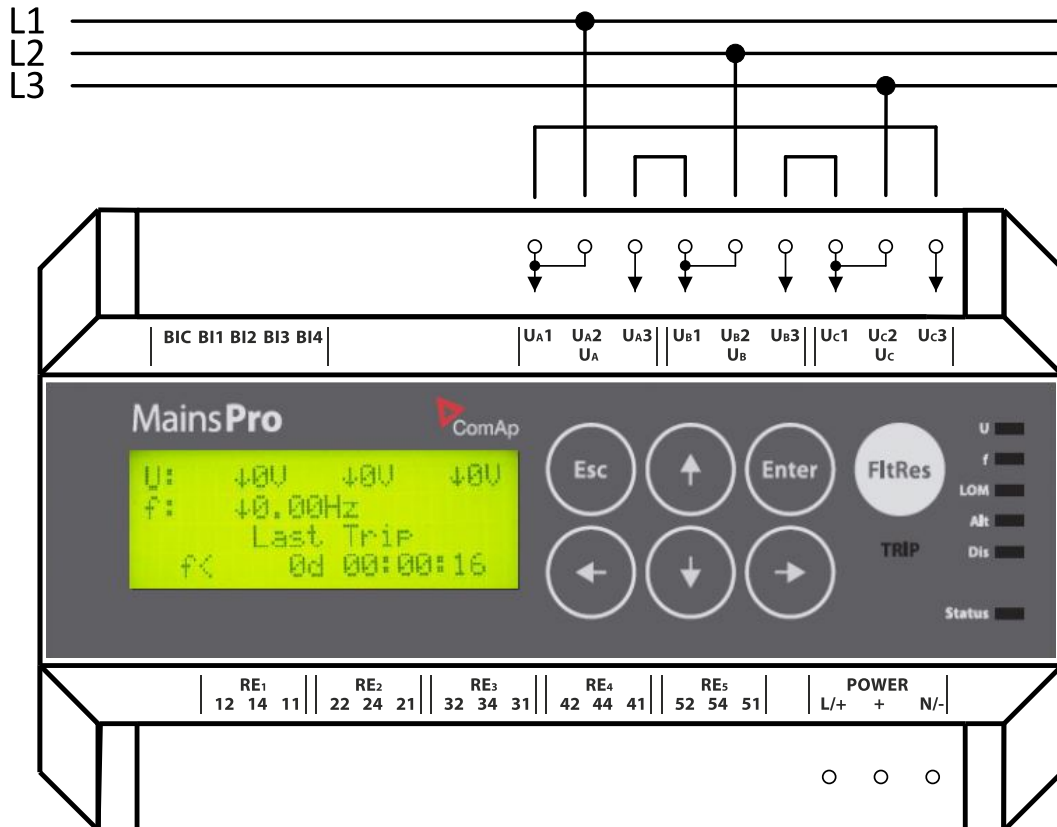

3.3.3 Connection with voltage transformers

MainsPro allows connecting HV or other measurement transformers with secondary rated voltage 100V. Provide the "Star" or "Delta" arrangement on the primary windings of the transformers and connect the secondary 100 V to the MainsPro measurement inputs. Setpoint **Uin** (page 53) is to be set to 120V. This setting provides the guaranteed measurement accuracy for the 100V inputs with overrange to 120V * 130% = 156 VAC.

Note: It is recommended to use “Delta” arrangement on the HV side to avoid nuisance tripping caused by phase voltage unbalance.

3.3.4 Single-phase connection

MainsPro provides support for single-phase applications. Use the UA terminals to connect the measured voltage to the unit and set the setpoint **System** (page 53) to 1ph. Use the same setting of rated voltage selection as mentioned above.

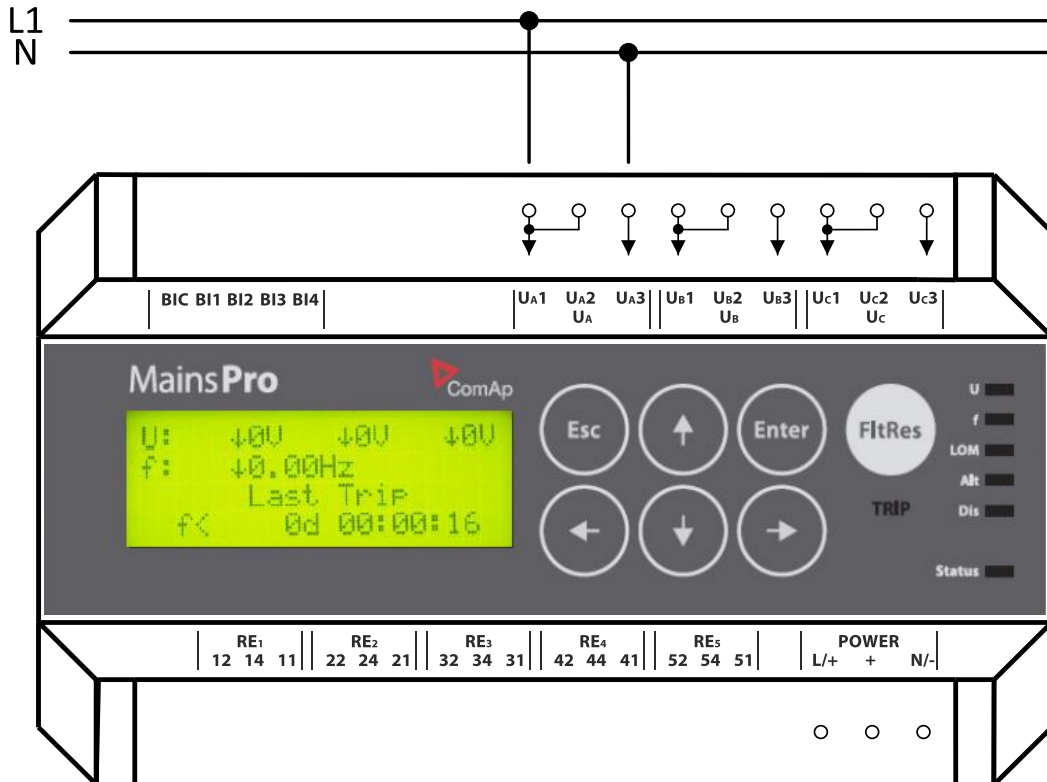

3.3.5 Power supply

MainsPro provides set of 3 terminals for the purpose of dual power supply range:

- ▶ 8 - 40 VDC: use the terminals + and N/-
- ▶ 85 - 265 VAC / 110-370 VDC: use the terminals L/+ and N/-

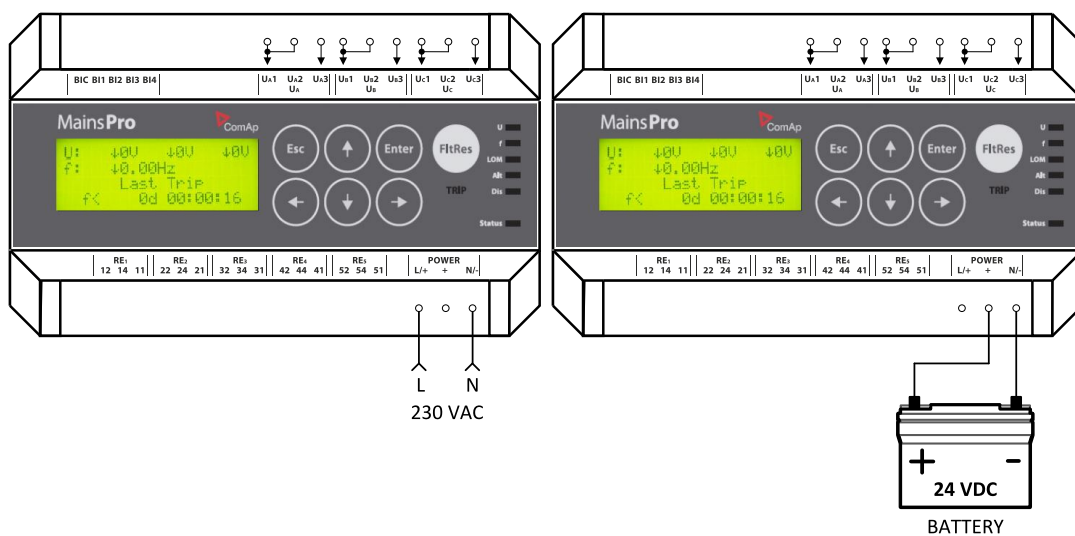

For proper connection of the power supply, see also the printed sign on the MainsPro unit:

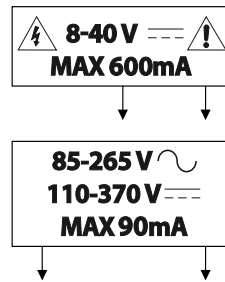

Requirements for power supply connections

The unit is suitable for permanent connection to the power supply. The power supply circuits must have sufficient current stability, corresponding to the appropriate power supply range and comply with the standards relevant for the installation.

Note: External power supply is recommended in order to avoid excess of allowed supply voltage (256Vrms, respectively 370V of peak value including dc offset).

Please be aware that not all power meters can detect the supply voltage including the dc component!

Note: The difference between power supply voltage and measured voltage must not exceed 1kV (peak-to-peak), otherwise external power supply with appropriate voltage stability is recommended to use. For isolated, ungrounded systems external, galvanically isolated power supply is recommended in all cases.

Requirements for power supply disconnecting device:

In case of power supply from AC voltage, the unit must be equipped by circuit breaker or contactor, marked as disconnecting device in accordance with the EN 61010-1 standard.

IMPORTANT: The power supply circuit 8-40 VDC is internally interconnected with the supply circuit 85-265 VAC. In case of operation with both power supply terminals connected, keep in mind, that a failure of insulation in the AC power supply may cause propagation of AC voltage into the circuits of low safe DC voltage, due to galvanic interconnection of both circuits!

3.3.6 Relay outputs connection

For safety purposes, it is recommended to set all MainsPro relay outputs to inverse logic for failure trips and signaling. This means that under fault-free conditions all contacts are kept in energized position. In trip or out-of-range signaling state, the contacts de-energize. In case of power-supply fail, the unit automatically moves to fault-signaling by de-energizing the output relays, assuring safety disconnection of the controlled devices. These outputs are marked with exclamation mark (i.e. !CommTrpPer).

However, the outputs can be set to normal logic which means, that in fault-free state all contacts are kept in de-energized position. In trip or out-of-range signaling state, the contacts energize. These outputs are without exclamation mark (i.e. CommTrpPer).

Relay outputs in MainsPro are freely assignable by the setpoints f(RE).

- ▶ In default configuration, RE1 serves as the permanently energized common trip output contact (**!CommTrpPer (page 64)**). Use this contact to operate the connector devices with permanently energized inputs.
- ▶ In default configuration, RE2 serves as an impulse common trip contact (**CommTrpImp (page 64)**). Use this contact to operate e.g. opening or UV coil of circuit breakers.
- ▶ Remaining 3 relay outputs serve for signaling of any sensed failure.
- ▶ The arrangement of RE1 to 4 outputs in default configuration corresponds to the functionality of the previous NPU-FUV unit outputs.

3.3.7 Binary switches connection

MainsPro provides 4 galvanically isolated binary switches with configurable functionality. These inputs allow connection of any voltage free contact between the common terminal BIC and the appropriate functional contact (BI1 – BI4).

Particular functions (Ext1, Ext2, Fault Reset, Alternative settings, Disable, CB Feedback) are freely assignable by setpoint in **Group: f(BI) (page 60)**.

Note: *It is not possible to assign the same function to two different Binary Inputs.*

For full description see **Library of Binary switches on page 62**.

3.4 Measurement range

MainsPro allows using multiple voltage ranges on the measurement inputs with unchanged measurement accuracy. The following ranges are applicable:

- ▶ 230 V - this range applies in case of "star" connection of the 3-phase system using nominal 230V phase to neutral. It may be also used for single-phase applications 230V phase to neutral. Overshoot by 30% up to 290V is possible for this measurement range. For this case, set the setpoint **Uin (page 53)** to 230/400V. MainsPro will adjust automatically the measurement method, to assure the defined accuracy for the measured voltage 230 V.
- ▶ 400 V - this range applies in case of "delta" connection of the 3-phase system using nominal 400V phase to phase. Overshoot by 30% up to 520V is possible for this measurement range. For this case, set the setpoint **Uin (page 53)** to 230/400V. MainsPro will adjust automatically the measurement method, to assure the defined accuracy for the measured voltage 400 V.
- ▶ 120 V - this range is applicable in countries using 120 V nominal voltage phase to neutral. Another application is for the high-voltage and other applications, using voltage transformers from rated voltage to 100 V. The guaranteed accuracy applies to both ranges 100 and 120 V. Overshoot by 30% up to 156V is possible for this measurement range. For this case, set the setpoint **Uin (page 53)** to 120V.

3.5 Wiring examples

This chapter provides examples of possible wiring of MainsPro which can be used as a preparation concept of wiring scheme.

Note: *ComAp bears no responsibility of functionality of the solution where these concepts are applied.*

- Under normal conditions the undervoltage coil is powered. In case of fault, the voltage is lost and the breaker undervoltage coil opens.

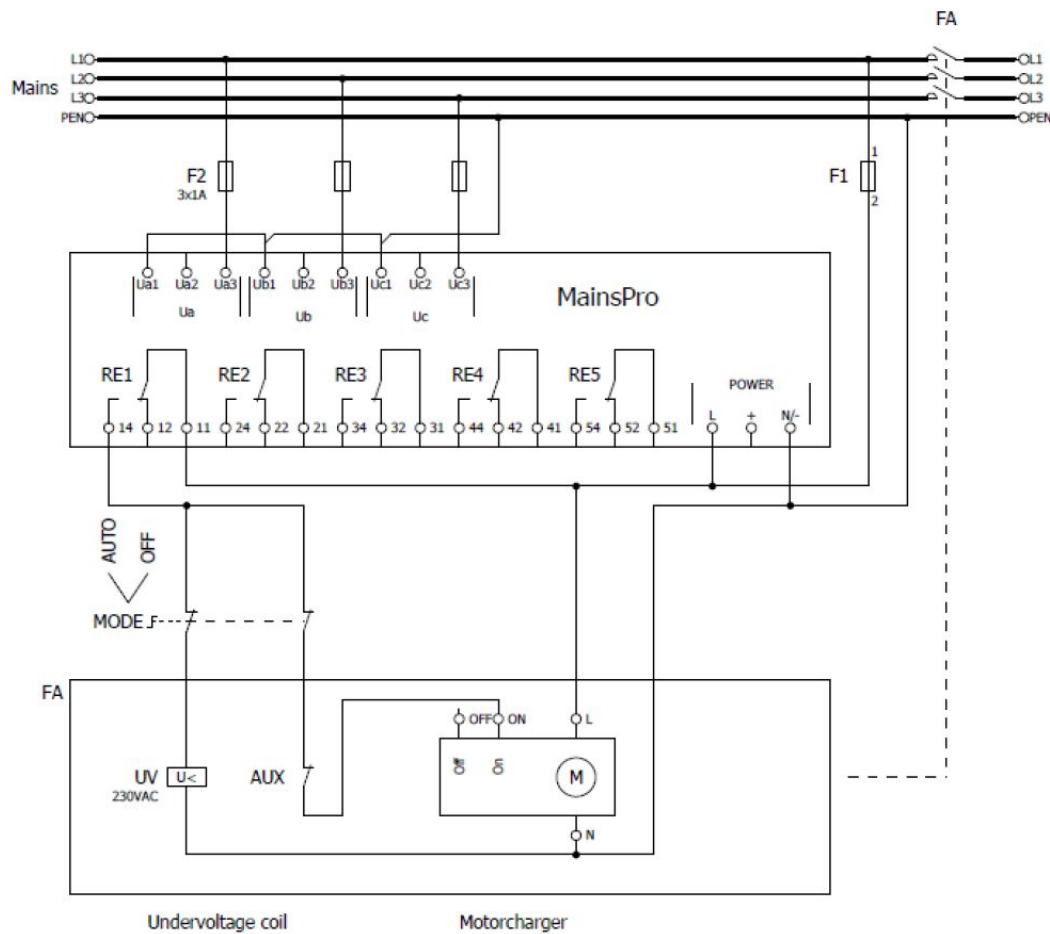

- Under normal conditions the Off coil is not powered and contacts are open. In case of failure, the contacts (12) close and the voltage is applied on the Off coil, therefore auxiliary power supply (e.g. UPS) is necessary to provide voltage for the Off coil.

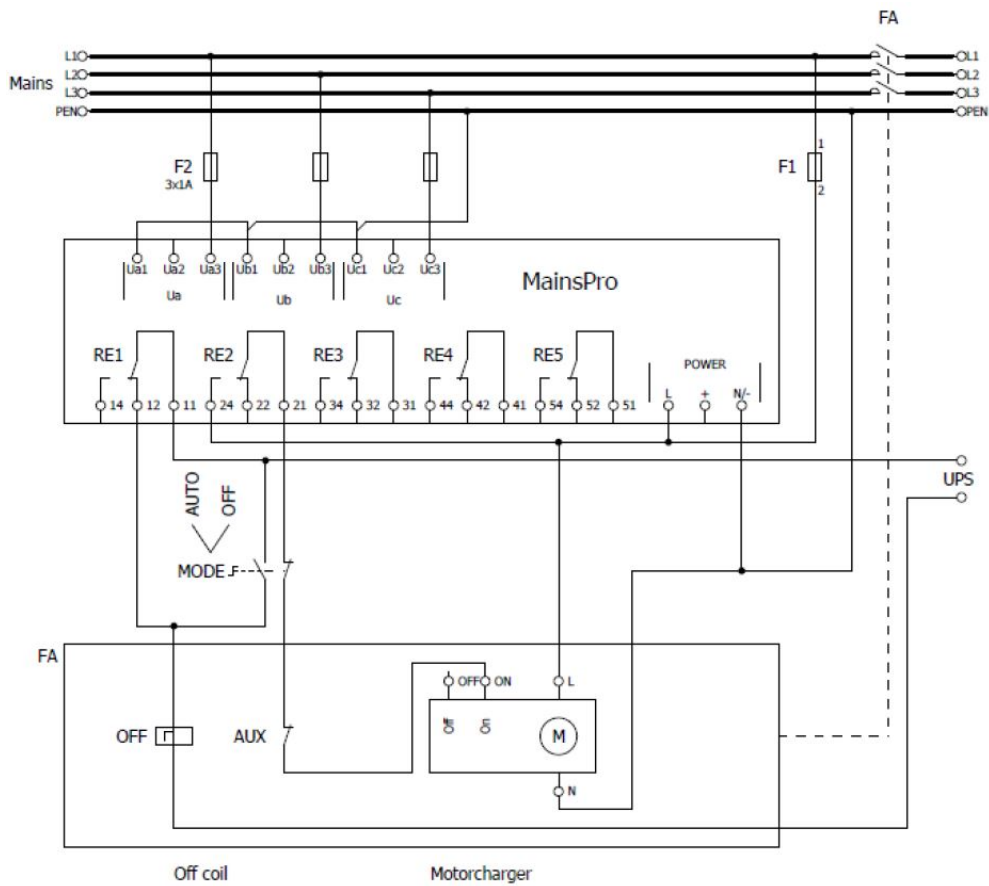

- Under normal conditions the contacts are closed, in case of failure the contacts open. This wiring is typically used for coil driven contactors.

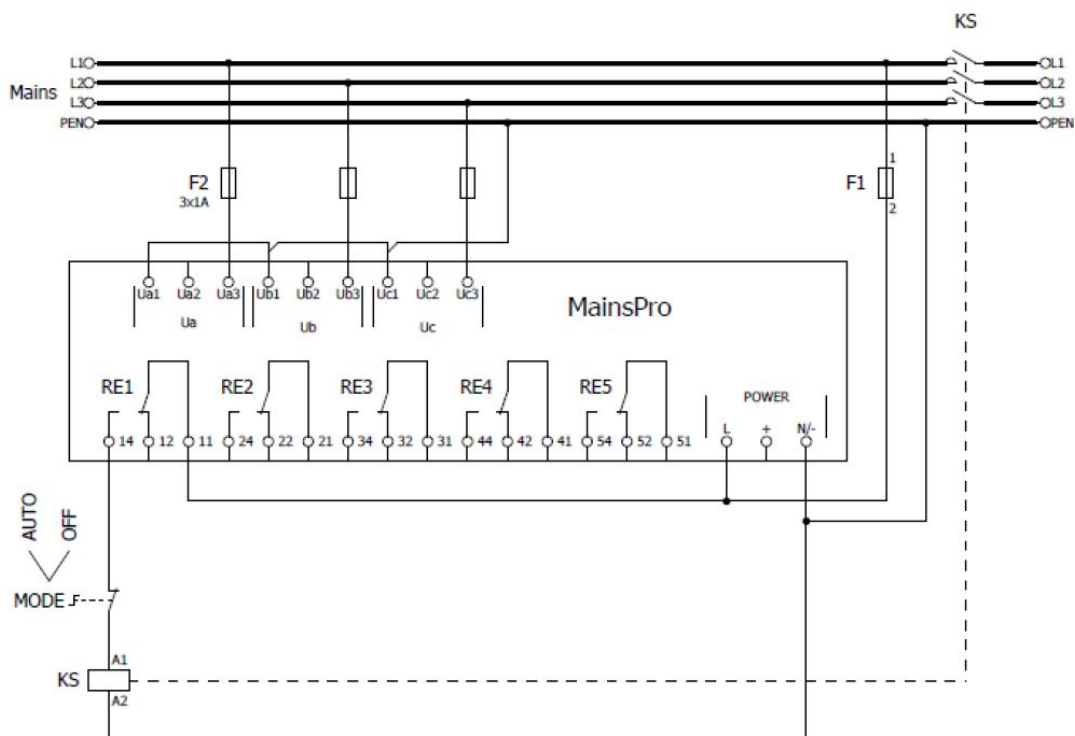

[back to Installation data](#)

4 User interface

- 4.1 Front panel elements 20
- 4.2 Mechanical sealing 23
- 4.3 Signalization LEDs 23
- 4.4 Measurement screens 25
- 4.5 Alarm messages 27

 [back to Table of contents](#)

4.1 Front panel elements

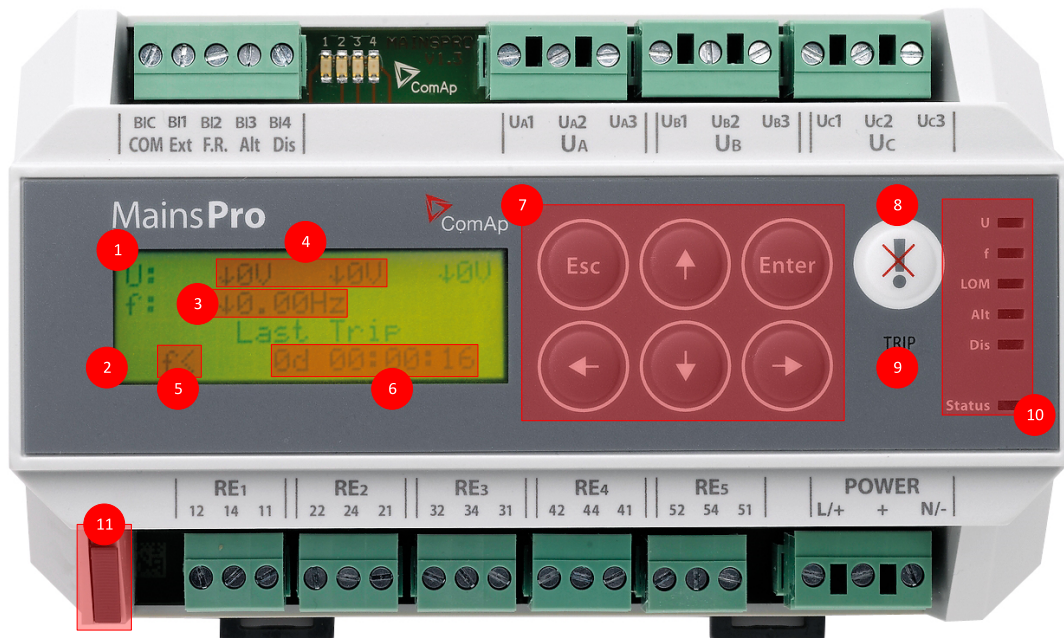

Number	Description
1	4 x 20 Alpha-numerical display
2	Mechanical sealing indication
3	Frequency measurement
4	3-phase voltage measurement
5	Last trip indication
6	Last trip timer
7	Control and navigation pushbuttons
8	Fault Reset button

Number	Description
9	TRIP LED
10	Singalization LEDs
11	Mechanical seal

4.1.1 Pushbuttons

- ▶ In the measurement screens, use the ↑ and ↓ arrow buttons to browse through the measured values as displayed on the 4x20 alphanumerical display. See the chapter **Measurement screens (page 25)** to get the basic orientation.
- ▶ To enter the setpoints menu, push the → button. For setpoints change, **see Setpoints change on page 21**.
- ▶ To enter the init screen, to reset operation time, perform factory default reset, reset statistics or enter the Test mode, push the **ENTER** and **ESC** at the same time. Together with the init screen display, the unit performs lamp test by simultaneous cycling of all LEDs through all indication colors.
- ▶ For confirmation of any value change or query, use the **ENTER** button.
- ▶ For leaving any value change or query screen without change, use **ESC** button.
- ▶ From any screen, press and hold the **ESC** button for 2 seconds to return back to the main measurement screen (homepage).

4.1.2 Setpoints change

1. Push the → button to open the setpoints menu.
2. Use buttons ↑ and ↓ to browse through the menu. The setpoint groups are displayed in a cyclical order, i.e. from the last setpoint group by button ↓, the cursor moves to the first group and vice versa.
3. Use button → to enter the setpoint group, by button ←, move one level up in the setpoint tree. The setpoints are displayed in a cyclical order, i.e. from the last setpoint by button ↓, the cursor moves to the first one and vice versa.
4. Press → to access the setpoint screen. Here you can change the setpoint value. The setpoint range is shown at the bottom row.
5. The change is done by orders, starting from the least important digit. Use the buttons ← and → to move between the digits. Use the buttons ↑ and ↓ to edit the digit. Please note, that the value is not limited by the parameters limits during editing, but if an out-of-limits value is set-up, it will not be allowed to be stored in the unit memory (the change may not be confirmed).
6. After the setpoint change is done, press **ENTER** to confirm the set value, or **ESC** to leave the setpoint change screen without saving the changes.

Note: The unit allows mechanical sealing of the setpoints by the black switch in left-bottom corner of the unit. If locked, the icon of closed padlock will appear on the position of setpoint change and the setpoints may not be changed. Also, the padlock icon will be seen on the "homepage" measurement screen. Once the setpoint change screen is entered and afterwards the sealing position is changed, the padlock indication is not changed, but the internal lock is applied immediately.

4.1.3 Reset operation time

1. Enter the init screen by pushing the **ENTER** and **ESC** at the same time.
2. Press ← to enter the Reset Oper.Time? screen:

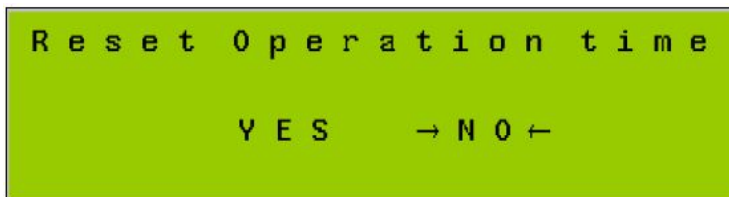

3. Using ← and → choose the required operation. By selecting YES, "Operation Time" timer will be reset, and the last five events will be deleted. Press **ENTER** to confirm your selection.
4. By selecting NO and pressing **ESC** or by pressing **ESC**, return to the measurement screens with no change.

4.1.4 Reset trip counters

1. Enter the init screen by pushing the **ENTER** and **ESC** at the same time.
2. Press ← and then use the buttons ↑ and ↓ to enter the Clear Statistics dialog screen:

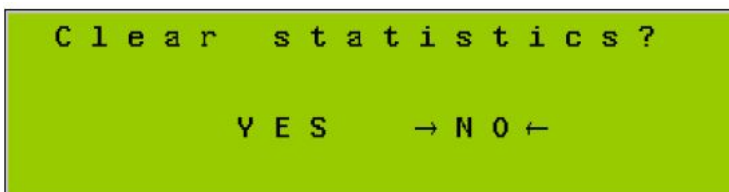

3. Using ← and → choose the required operation. By selecting YES, all trip counters will be reset. Press **ENTER** to confirm your selection.
4. By selecting NO and pressing **ENTER** or by pressing **ESC**, return to the measurement screens with no change.

4.1.5 TEST mode activation

1. Enter the init screen by pushing the **ENTER** and **ESC** at the same time.
2. Press ← and then use the buttons ↑ and ↓ to enter the Test mode activation screen:

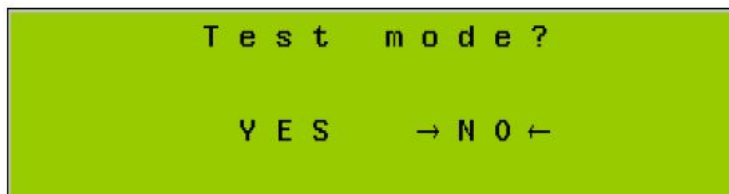

3. Using ← and → choose the required operation. By selecting YES, you will activate the TEST mode - see the chapter **TEST mode (page 43)** in Application Guide. Press **ENTER** to confirm your selection.
4. By selecting NO and pressing **ENTER** or by pressing **ESC**, return to the measurement screens with no change.

4.1.6 Factory default

MainsPro contains a default set of all setpoints, which corresponds to the typical requirement of distribution network operator in some countries.

1. Enter the init screen by pushing the **ENTER** and **ESC** at the same time.
2. Press ← and then use the buttons ↑ and ↓ to enter the Factory default activation screen:

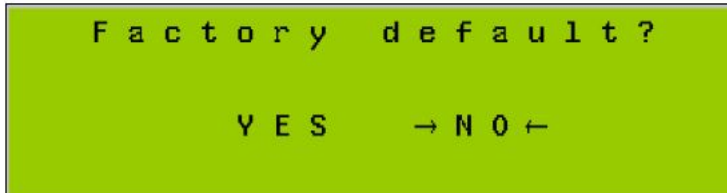

3. Using ← and → choose the required operation. By selecting YES, you will return all previously done setting to the default values. **Please note that by this selection, you will lose all setting done prior to this operation!** Press **ENTER** to confirm your selection.
4. By selecting NO and pressing **ENTER** or by pressing **ESC**, return to the measurement screens with no change.

4.2 Mechanical sealing

MainsPro allows to mechanically prevent the setting changes of selected setpoints by securing the mechanical seal in locked position by sealing wire. The locked position is indicated at the MainsPro side-print and on the alphanumerical display. For information what setpoints are sealing protected see **Factory default setting of MainsPro unit (page 48)**.

4.3 Signalization LEDs

- ▶ There are 7 LEDs for indication of MainsPro status with the meaning indicated in the table below
- ▶ In case of signaling different statuses by one LED, the following priorities apply, i.e. the higher priority signal is provided by the LED:
 - Red flashing
 - Red
 - Orange flashing
 - Orange
 - Green

Note: The U and f signalization is immediate at detection of fault conditions, regardless of the set delay for the unit trip. After the conditions get back to the fault-free state, the LEDs may move back to green colour, regardless of whether the unit is currently in TRIP status.

- ▶ Indication of LED LOM is immediate at detection of the particular protection stage (Vector shift or ROCOF) and fault indication remains active for the period of time, set by the setpoint Basic: Imp Len Del.
- ▶ TRIP signalization is delayed according to the particular delay of the appropriate protective stage.

Meaning of signaling LEDs

LED	Color	Meaning
TRIP	Red	The unit has the appropriate outputs in TRIP position and the unit is sensing a fault situation
	Red flashing	The unit has the appropriate outputs in TRIP position, but the unit is sensing fault-free situation. Fault reset is possible.
	Dark	The unit has no output in TRIP position
U	Red flashing	Voltage of any phase is above threshold for 1st or 2nd stage overvoltage
	Red	Voltage of any phase is under threshold for 1st or 2nd stage undervoltage
	Orange flashing	Voltage unbalance (amplitude) is indicated. If activated together with LED f and LOM, indicates incorrect phase rotation
	Orange	Negative sequence overvoltage or Positive sequence undervoltage is indicated. If activated together with LED f and LOM, indicates incorrect polarity of one phase
	Green	All voltages are in fault-free state
	Green flashing	Floating 10 minutes average overvoltage (page 35) is detected
	Dark	Over/under voltage protections are not enabled by setpoint and no other voltage failure is sensed
f	Red flashing	Frequency as sensed on terminals Ua is above threshold for 1st or 2nd stage overfrequency
	Red	Frequency as sensed on terminals Ua is under threshold for 1st or 2nd stage underfrequency
	Orange flashing	Together with LED U and LOM, indicates incorrect phase rotation
	Orange	Together with LED U and LOM, indicates incorrect polarity of one phase
	Green	Frequency, rotation and phases polarity are in fault-free state
	Dark	Over/under frequency is protections are not enabled by setpoint and no other indicated failure is sensed
LOM	Red	Vector shift or ROCOF protection was indicated and Fault reset was not yet done
	Orange flashing	Together with LED U and f, indicates incorrect phase rotation
	Orange	Together with LED U and f, indicates incorrect polarity of one phase
	Dark	None of Vector shift or ROCOF failure is detected or neither Vector shift nor ROCOF protections are not enabled by setpoint and no other indicated failure is sensed

LED	Color	Meaning
Status	Red flashing	Indication of severe internal failure. Contact ComAp technical support!
	Orange flashing	Indication of internal failure. Contact ComAp technical support!
	Orange	Indication of internal failure. Contact ComAp technical support!
	Green	The unit is in operation with no internal problems.
	Dark	The unit is not in operation
Alt	Orange	The function Alternative setting is activated by means of binary switch Alt setting.
	Dark	The function Alternative setting is not activated
Dis	Orange	The unit is disabled by means of binary switch Disable
	Dark	The unit is not disabled by means of binary switch Disable

4.4 Measurement screens

Following are the examples of the measurement screens, showing values measured and evaluated by the unit:

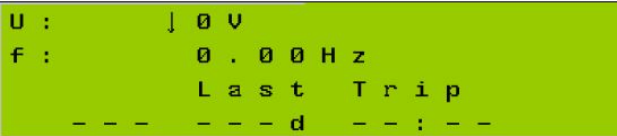
<p>Main measurement screen (homepage), 3-phase application:</p> 	<ul style="list-style-type: none"> ▶ U: measured voltages on terminal sets Ua, Ub and Uc. If overvoltage or undervoltage is detected on a particular phase, arrow symbol is displayed left of the particular voltage value. ▶ f: measured frequency on terminal set Ua. If overfrequency or underfrequency is detected, arrow symbol is displayed left of the frequency value. ▶ Last Trip: indication of the latest event which caused the protection activation (trip). See the following chapter for trip messages explanation.
<p>Main measurement screen (homepage), 1-phase application (setpoint System set to 1ph):</p> 	<ul style="list-style-type: none"> ▶ U: measured voltage on terminal set Ua. If overvoltage or undervoltage is detected, arrow symbol is displayed left of the voltage value. ▶ f: measured frequency on terminal set Ua. If overfrequency or underfrequency is detected, arrow symbol is displayed left of the frequency value. ▶ Last trip: indication of the latest event which caused the protection activation (trip).
<p>Loss of mains (LOM) measurement screen:</p>	<ul style="list-style-type: none"> ▶ Max Vs: maximum value of measured Vector shift since unit power-up or since

<pre> Max Vs 0.0° Act RCF 0.00 Hz / s Max RCF 0.00 Hz / s </pre>	<p>the last reset Vector shift trip.</p> <ul style="list-style-type: none"> ▶ Act RCF: actual measured value of ROCOF protection ▶ Max RCF: maximum value of measured ROCOF protection since unit power-up or since the last reset ROCOF trip.
<p>Voltage asymmetry measurement screen:</p> <pre> V asymmetry 0 V V negative 0 V V positive 0 V </pre>	<ul style="list-style-type: none"> ▶ V asymmetry: actual value of asymmetry of effective values measured on terminals Ua, Ub, Uc ▶ V negative: actual value of negative sequence voltage ▶ V positive: actual value of positive sequence voltage <p>Negative sequence overvoltage and positive sequence undervoltage are methods of evaluation of angle asymmetry of the 3-phase voltage system. See more in the chapter Voltage unbalance (page 37).</p>
<p>Binary switches status screen:</p> <pre> Fault reset I Alt settings (I) </pre>	<ul style="list-style-type: none"> ▶ List of the assigned binary switches. Functions that are configured are displayed in the appropriate order. Its status is displayed in brackets.
<p>Relay outputs 1-4 status screen:</p> <pre> RE1 (CommTrpPer) 0 RE2 (CommTrpImp) I RE3 (CommSigImp) I RE4 (CommSigDel) 0 </pre>	<ul style="list-style-type: none"> ▶ Status of the first 4 MainsPro relay outputs. Name in parentheses marks the function assigned by the setpoints in group f(RE).
<p>Relay output 5 status screen:</p> <pre> RE5 (U Sig) 0 </pre>	<ul style="list-style-type: none"> ▶ Status of the 5th MainsPro relay output. Name in parentheses marks the function assigned by the setpoints in group f(RE).
<p>Trip counters and indication screen:</p> <pre> Last Trip : - TripCnt : 0 U : 0 LOM: 0 f : 0 otr: 0 </pre>	<ul style="list-style-type: none"> ▶ Last Trip: indication of the latest event, which caused trip. See the following chapter for trip messages explanation. ▶ TripCnt: total counter of MainsPro trips since the MainsPro unit counters reset ▶ U: counter of overvoltage and undervoltage -related trips

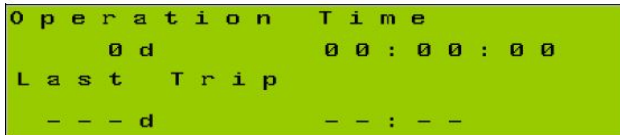
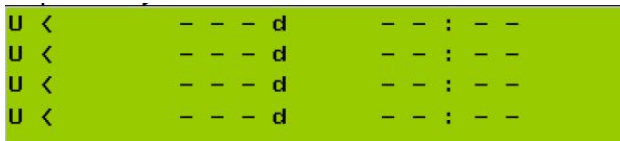
	<ul style="list-style-type: none"> ▶ f: counter of overfrequency and underfrequency - related trips ▶ LOM: counter of Loss-of-Mains - related trips (Vector shift and ROCOF) ▶ Otr: counter of trips with other reason than the above mentioned: Ext1 or Ext2 trip, voltage asymmetry, phase sequence or inverse phase polarity
<p>Time measurement screen:</p> 	<ul style="list-style-type: none"> ▶ Operation Time: time since MainsPro was powered up* ▶ Last Trip Time: time of the latest trip since MainsPro was powered-up <p>Please note that the time information on the MainsPro unit is not measured by a calibrated RTC device and may serve for orientation purposes only. Find more in Technical data (page 46).</p>
<p>Trip history screen</p> 	<p>List of last five trips - contains reason of the trip and time since the unit was powered up</p>

Note:

**For case of power cut off, the time stamp is stored and after the unit is powered up again, the timer will start from the from following second after the last stored one.*

4.5 Alarm messages

One of these indications appears on the homepage screen in case of the unit trip. It indicates the first protective stage, which issued the trip event:

f>	Overfrequency, 1st stage
f>>	Overfrequency, 2nd stage
f<	Underfrequency, 1st stage
f<<	Underfrequency, 2nd stage
U>	Overvoltage, 1st stage
U>>	Overvoltage, 2nd stage
U<	Undervoltage, 1st stage
U<<	Undervoltage, 2nd stage
Vs	Vector shift
RCF	ROCOF

Vunb	Voltage (amplitude) unbalance
Vneg	Negative sequence overvoltage
Vpos	Positive sequence undervoltage
Vavg	10 minutes floating average overvoltage
Rot	Wrong phase rotation
Pol	Wrong polarity of one phase
Ext1	External trip
Ext2	External trip
STr	Start Trip

 [back to User interface](#)

5 Introduction of Application Guide

5.1 Purpose of this manual	29
5.2 MainsPro typical usage	29
5.3 Typical applications of MainsPro protection relay	29

 [back to Table of contents](#)

5.1 Purpose of this manual

The Application Guide serves for the designers and engineers who process the necessary documentation and implementation procedures on the site where MainsPro is installed. It contains detailed description of MainsPro functionalities and their practical application.

5.2 MainsPro typical usage

MainsPro is a mains protective relay protecting operation of parallel-to-mains generators or other electrical resources of distributed generation of electricity. The main purpose is to prevent unwanted interaction between the generator and mains in case of its abnormal state (e.g. mains failure):

- ▶ Specific situations may occur, causing e.g. the utility network to momentarily disconnect part of the network and connect it back by automatic-recloser. During this fault-clearing period, the generators may get out of synchronism and their eventual re-connection may cause severe damage to the property of the generator operator, or to the utility equipment.
- ▶ The sole operation of a generator into an unintentionally islanded part of electricity network provides potentially dangerous situation. The load of the area may exceed the generator capacity and cause instability of the voltage, delivered to the consumers connected in the islanded area.
- ▶ Severe hazards may occur to the working personnel on the grid equipment in the area, where the mains is presumed as failed, but there are still generators delivering power into this area without central control of their operation.

These are some of the situations, leading the utilities to strictly require that any parallel connection to the mains is approved and protection devices with required protective features are installed.

5.3 Typical applications of MainsPro protection relay

- ▶ These are installations of any sources of electrical energy. For example:
- ▶ Cogeneration
- ▶ Peak-opping power stations
- ▶ Stand-by generators with soft return/short-time parallel operation with mains
- ▶ Microturbines

- ▶ Small hydro power plant
- ▶ Photovoltaic power plant
- ▶ Wind power plant
- ◀ **back to Introduction of Application Guide**

6 Important Steps of MainsPro utilization

This process describes a typical decisions and technical steps to follow in case of MainsPro utilization, if required by the distribution network operator (DNO).

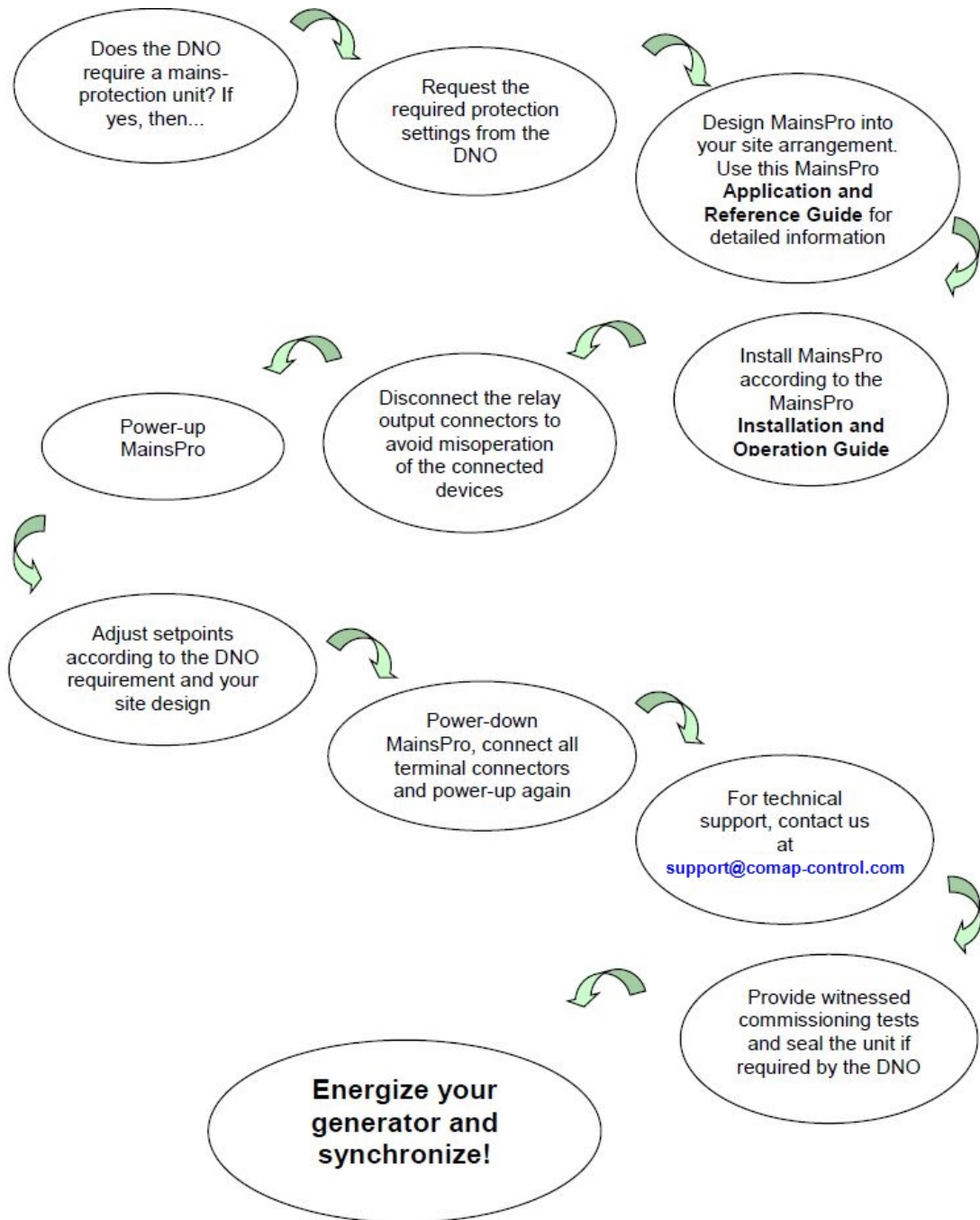

7 TRIP and Fault Reset

7.1 TRIP	32
7.2 Fault reset	33

 [back to Table of contents](#)

7.1 TRIP

TRIP may be considered as event or status of the unit (see chapters below).

7.1.1 TRIP event

- ▶ Starts in the moment of terminating the count-down of any protective function with delay, or in the moment of activation of any immediate protective function.
- ▶ A trip event leads to the following relay states:
 - Immediate deactivation of outputs !CommTrpPer and !CommTrpImp or activation of CommTrpPer and CommTrpImp
 - The TRIP LED turns red
 - The appropriate counter in the statistics screen increments
 - The cause of the TRIP event is recorded among the last five history events
 - The Last Trip Time timer starts to count time and the last trip indication is set

7.1.2 TRIP status

- ▶ Starts at the moment of TRIP event
- ▶ During this status, the appropriate outputs are kept in fault position
- ▶ During this status, it is not possible to perform Fault reset
- ▶ TRIP status is active until a successful Fault reset. The fault reset can only be performed when all measured and evaluated values are within preset limits.
- ▶ While the unit is in TRIP status, other TRIP conditions are evaluated but they do not log as another TRIP event. This is still indicated by the individual LEDs on the unit front panel.
- ▶ If the BI Disable is set to ENABLED and the BI Disable is activated during this state, the TRIP status is terminated and the fault is reset.
- ▶ If the BI Disable is set to ENABLEDexITRP and the BI Disable is activated during this state, it will have no effect on the unit.

7.2 Fault reset

Fault reset is an event, caused by one of the following reasons:

- ▶ FltRes button is pressed
- ▶ Binary switch Fault reset is activated
- ▶ Automatic fault reset timer set by setpoint **Auto FR Del [s]** (page 54) has counted down. The timer is started in the moment when all evaluated values are back within their limits. If during the count-down another fault status appears, the timer is reset and started only after all evaluated values are back within their limits again.

The above mentioned reasons are a trigger to perform Fault reset. The actual Fault reset is performed only in case the TRIP status is active and all evaluated values have returned back into limits.

The Fault reset will not be performed if the following is true:

- ▶ The TRIP is not active
- ▶ The TRIP is active but any of the measured values is out of limits of normal operational state

In such cases the Fault reset trigger is ignored.

By a successful Fault reset, the TRIP status is terminated.

🔍 **back to TRIP and Fault Reset**

8 Protective features

The following protective functionalities, referred also by their ANSI number, are available in MainsPro unit:

8.1 ANSI 59 Overvoltage, ANSI 27 Undervoltage	34
8.2 Floating 10 minutes average overvoltage	35
8.3 ANSI 81H Overfrequency, 81L Underfrequency	35
8.4 ANSI 47 Voltage unbalance and angle asymmetry	37
8.4.1 Voltage unbalance	37
8.4.2 Positive sequence undervoltage, Negative sequence overvoltage	37
8.5 ANSI 78 Vector shift	38
8.5.1 Measuring principle	39
8.6 81R Rate Of Change Of Frequency (ROCOF)	40
8.7 Phase rotation, incorrect phase polarity	40

 [back to Table of contents](#)

8.1 ANSI 59 Overvoltage, ANSI 27 Undervoltage

The RMS value of measured voltage is compared with the preset limit of overvoltage or undervoltage. When any of the preset thresholds is crossed, the appropriate LED signal is issued by LED U and the output U Sig moves to fault-indicating position immediately. If voltage in the given phase keeps out of limits for the delay of the appropriate stage, **TRIP (page 32)** is issued. As the voltage returns back within limits in all measured phases, the LED and **U Sig (page 65)** output stop to signal the fault state immediately, regardless of whether **TRIP (page 32)** was issued or not or **Fault reset (page 33)** was performed or not. Both overvoltage and undervoltage protective stages provide possibility of setting 2 levels with independent delay assigned to each level.

To avoid any unwanted oscillation around the undervoltage or overvoltage limit, there is a possibility to set up a voltage hysteresis. The principle is shown in the pictures below. After overvoltage situation, voltage must decrease under the hysteresis limit to clear the fault. After undervoltage situation, voltage must exceed the hysteresis limit to clear the fault.

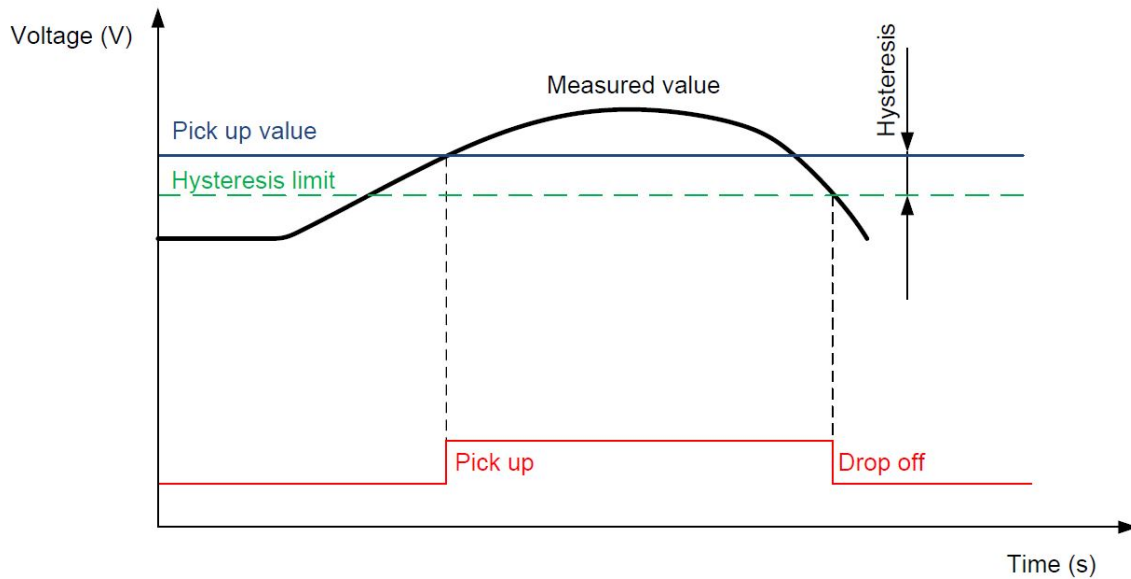

Image 8.1 Voltage hysteresis for overvoltage

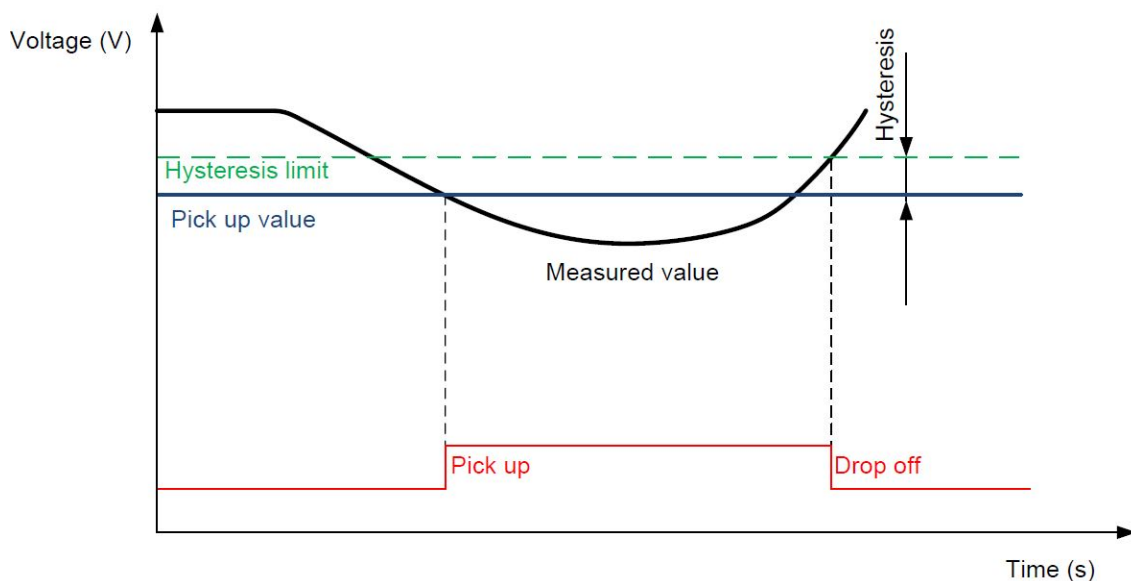

Image 8.2 Voltage hysteresis for undervoltage

8.2 Floating 10 minutes average overvoltage

The unit calculates floating average of the measured voltage in each phase over 10 minutes interval. If any of the three phase values crosses the threshold set by **Avg V> [V]** (page 56), **TRIP** (page 32) is issued, LED U flashes and counter of voltage disturbances is incremented. As the Last Trip record, the message "Vavg" is displayed. The protection stage is blocked for the first 10 minutes after power-up of the unit.

8.3 ANSI 81H Overfrequency, 81L Underfrequency

The frequency value measured on phase L1 is compared with the preset limit of overfrequency or underfrequency. When any of the preset thresholds is crossed, the appropriate LED signal is issued by LED f

and the output **f Sig** (page 66) moves to fault-indicating position immediately. If the frequency keeps out of limits for the delay of the appropriate stage, **TRIP** (page 32) is issued. As the frequency returns back within limits, the LED and **f Sig** (page 66) output stop to signal the fault state immediately, regardless of whether **TRIP** (page 32) was issued or not or **Fault reset** (page 33) was performed or not.

Both overfrequency and underfrequency protective stages provide possibility of setting 2 levels with independent delay assigned to each level.

Note: *MainsPro measures frequency on the phase L1 only, therefore frequency measurement will be distorted in case that a fault occurs in this phase.*

To avoid any unwanted oscillation around the underfrequency or overfrequency limit, there is a possibility to set up a frequency hysteresis. The principle is shown in the pictures below. After overfrequency situation, frequency must decrease under the hysteresis limit to clear the fault. After underfrequency situation, frequency must exceed the hysteresis limit to clear the fault.

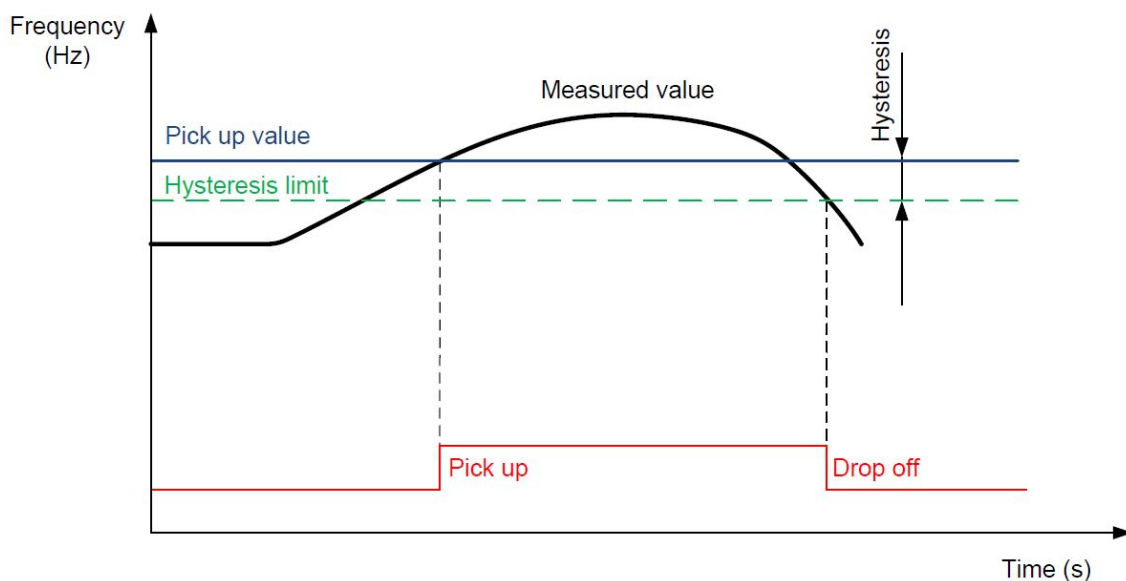

Image 8.3 Frequency hysteresis for overfrequency

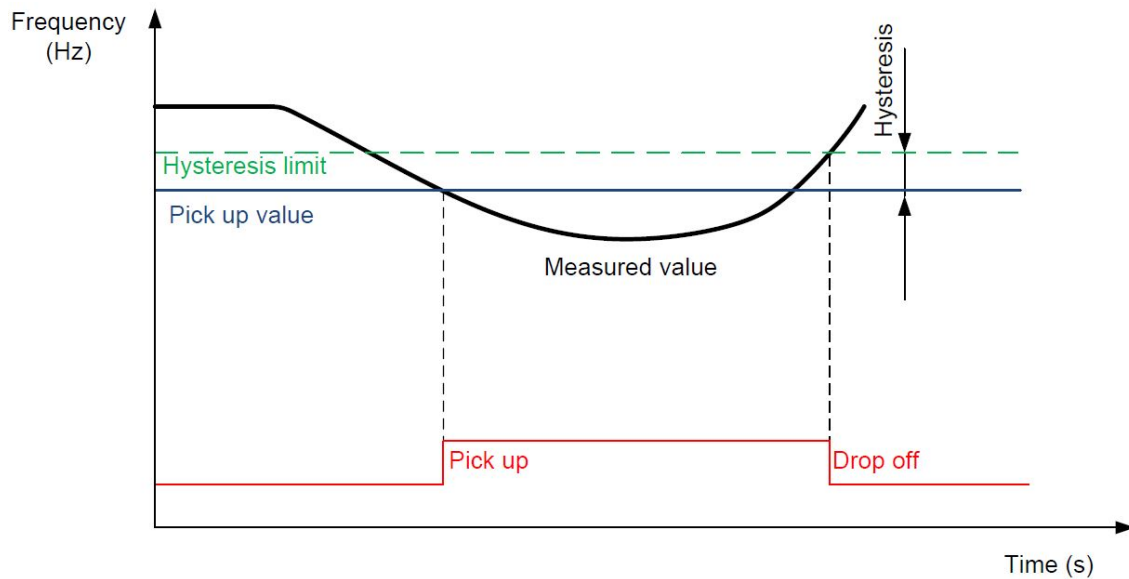

Image 8.4 Frequency hysteresis for underfrequency

8.4 ANSI 47 Voltage unbalance and angle asymmetry

MainsPro provides 3 independent methods for evaluation of voltage symmetry failures. All of these protections are only active in case that 3-phase system is selected by the setpoint **System** (page 53).

8.4.1 Voltage unbalance

In further text, this term refers to the state, when amplitude difference between any 2 phases exceeds the preset limit **V unb, A.V unb [V]** (page 57). I.e., it refers to the amplitude unbalance of the measured voltage.

8.4.2 Positive sequence undervoltage, Negative sequence overvoltage

These two methods provide very good sensitivity also to angle asymmetry of the measured voltages. The evaluation is based on the mathematical principle of evaluation of the symmetrical components of measured voltage. Any 3-phase system in any asymmetrical arrangement may be decomposed to 3 perfectly symmetrical components:

- ▶ Positive sequence - system of 3 phases with 120° phase-shift between the system vectors and the same phase-order as the original system.
- ▶ Negative sequence - system of 3 phases with 120° phase-shift between the system vectors and opposite phase-order as the original system.
- ▶ Zero sequence - system of 3 conphase vectors (with 0° phase-shift between the phases).

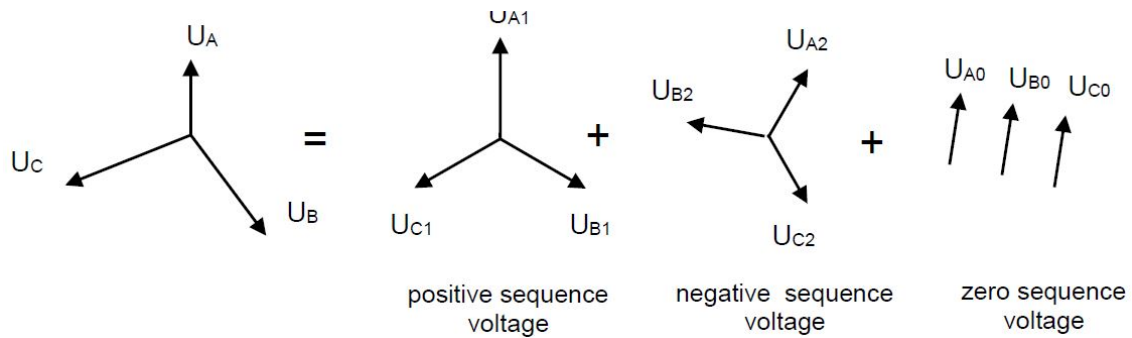

Image 8.5 Decomposition of a generic 3-phase voltage to symmetrical components

MainsPro provides positive and negative sequence voltage evaluation and compares the measured values with **V> neg, A.V> neg [V] (page 58)** and **V< pos, A.V< pos [V] (page 57)** thresholds. In the perfectly symmetrical arrangement, negative sequence voltage is zero and positive sequence voltage equals to the measured voltage. If the asymmetry situation occurs, non-zero negative sequence voltage is calculated and positive sequence voltage drops. When any of the preset thresholds is crossed, the appropriate LED signal is issued by LED U and the output **dU Sig (page 66)** moves to fault-indicating position immediately. If the calculated values keep out of limits for the delay **dU del, TRIP (page 32)** is issued. As the calculated values of voltage asymmetry return back within limits, the LED and **dU Sig (page 66)** output stop to signal the fault state immediately, regardless of whether **TRIP (page 32)** was issued or not or **Fault reset (page 33)** was performed or not. Some utilities strictly require in their regulations that symmetrical components are evaluated in the mains-decoupling relay and an appropriate trip is provided. However, the method may also be used in the areas, where no such requirement is in place, to minimize non-detection zones of detection of 1-phase mains failures. In case that the generator, connected to the mains is operated close to equity-state, i.e. power delivered to the mains is close to zero, it may be difficult to sense loss of one phase further in the system. The only change seen in such situation may be movement of the failed phase by a certain angle with small or no voltage drop in the absolute values. This may not be detected by undervoltage or unbalance protection stage. Symmetrical components provide very good and sensitive method to detect such a situation and trip the generator in case of this situation.

Typical setting of the **V< pos** varies from 0,65 to 0,85 of the rated voltage value. The exact values are provided by the DNO or may be set-up during commissioning after experimental verification of the protection stage sensitivity to the single-phase failures in equity state of the generator (e.g. by opening one fuse on the mains transformer).

Note: If a rapid voltage drop from 230V to e.g. 50V occurs in the phase L1, tripping times might be longer and can reach 100ms.

8.5 ANSI 78 Vector shift

The vector shift is one of the fast "Loss of Mains" protection stages. The principle is based on the fact that if a generator works into an islanded area of the electricity network, its voltage and frequency depend strongly on the load size, remaining in the islanded area. Decrease of the generator speed due to overload may not be fast enough to assure e.g. trip by underfrequency stage. The mains may be equipped with auto-reclosing mechanisms and in case that the generator is not disconnected within the auto-reclosing delay, the area may be reconnected back to the grid by this mechanism. This reconnection may meet the generator in asynchronous state, imposing risk of severe damage to the generator, its feeder equipment as well as equipment in the actual grid. Vector shift provides fast protective function for this situation.

8.5.1 Measuring principle

When synchronous alternator is loaded, the rotor displacement angle ϑ is built between the terminal voltage (mains voltage) \vec{U}_g and the synchronous electromotive force \vec{U}_e . Therefore a voltage difference ΔU is built between \vec{U}_e and \vec{U}_g . The rotor displacement angle ϑ between stator and rotor is depending on mechanical moving torque of the generator shaft. The mechanical shaft power is balanced with the electrical feeder mains power and therefore the synchronous speed keeps constant.

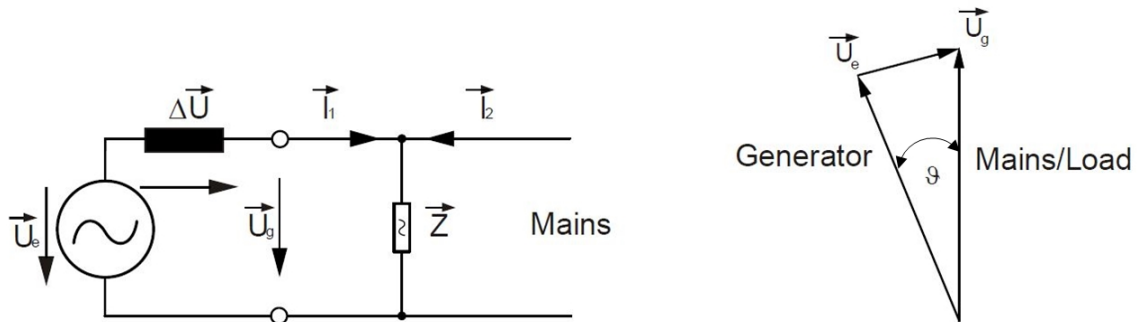

Image 8.6 In parallel with the mains

In case of mains failure or auto reclosing the generator suddenly feeds a very high consumer load. The rotor displacement angle is decreased repeatedly and the voltage vector \vec{U}_g changes its direction to \vec{U}_g' .

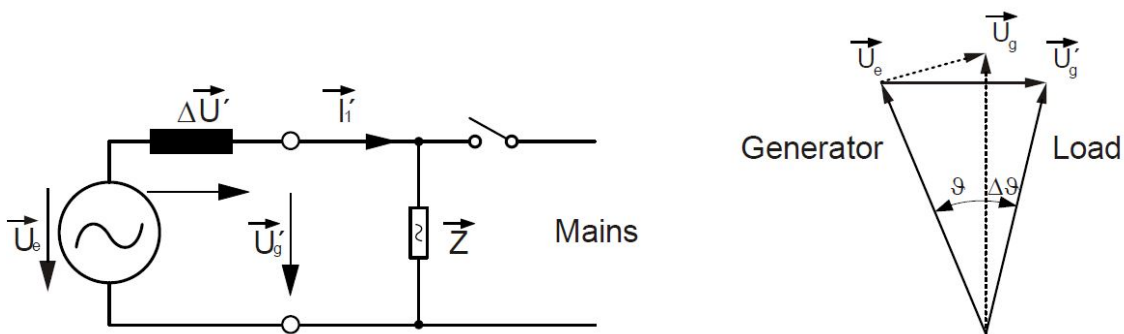
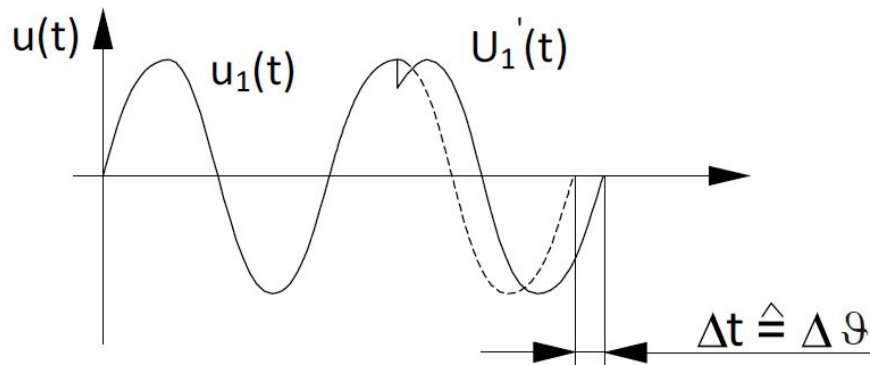

Image 8.7 At mains failure

As shown in the timing diagram the voltage jumps to another value and the phase position changes. This procedure is called phase or vector surge. MainsPro continuously measures the cycles, starting each zero up ward slope. The time cycle is internally compared to the reference time. In case of vector surge the zero up ward is delayed and the device trips instantaneously. The trip angle $\Delta \vartheta$ and consequently the sensitivity of the vector surge detection is adjustable by the setpoint **VS lim, A.VS lim [°]** (page 59).



Proper setting of Vector shift limit has to be examined at the field tests, especially at very low setting of the protection limit (under 3°). Vector shift is very fast method and may be sensitive to disturbances, naturally present in the electricity grid.

Note: Due to high sensitivity, Vector shift protection is not evaluated in the transient states, e.g. when Alt settings functionality is turned on or off, Fault reset (page 33) is performed or Vector shift limit is being set. Functionality is blocked in the sine wave period, when such an event occurs.

8.6 81R Rate Of Change Of Frequency (ROCOF)

ROCOF is another fast "Loss of Mains" protection stage provided in MainsPro. It is based on a similar principle as Vector shift, i.e. dependence of the generator speed and voltage on the load size. The variations of frequency delivered by the gen-set depend on the load fluctuations and gen-set speed regulation capability. In case of operation in parallel with large network, these changes are absorbed in the network and frequency is stable. When the connected area disconnects from the mains into island operation, the frequency becomes unstable. MainsPro ROCOF stage provides fast evaluation of the frequency instability and TRIPS immediately in case of fast frequency changes. The threshold is set by the setpoint **ROCOF**, **A.ROCOF [Hz/s]** (page 59). As the ROCOF stage provides very sensitive protection, software filter may be set using the LOM: ROCOF filter setpoint. By appropriate setting of those two setpoints, perfect ratio between sensitivity and speed of reaction of ROCOF protection may be established at the field tests.

Note: ROCOF is sensitive to voltage jumps, therefore it is recommended to be disabled during tests of overvoltage and enabled after tests are finished.

8.7 Phase rotation, incorrect phase polarity

MainsPro provides check of the phase sequence and polarity. The correct connection is indicated in the wiring instructions e.g. on MainsPro box or in chapter **Wiring** (page 12), where clockwise rotation system is expected on the mains side. It may happen, that e.g. by redesign in the mains or generator site installation, the phase rotation changes. MainsPro ensures in such case, that this state is indicated and it prevents incorrect closing of the circuit breaker by its standard protective functionality. To allow phase sequence or incorrect phase polarity check, the phase angle between the 3 voltage vectors is expected in range 120° +/- 30°. If a wrong phase arrangement is detected, **TRIP** (page 32) is issued and the appropriate LED signalization is given. The reconnection of measurement terminals is necessary to ensure further proper functionality of the unit.

 **back to Protective features**

9 Application tips

9.1 Automatic return to mains	41
9.2 Binary switches	41
9.3 Counters	42
9.4 Timer	43
9.5 Start trip	43
9.6 TEST mode	43

 [back to Table of contents](#)

9.1 Automatic return to mains

Some utilities require that the protection unit provides an automatic return of the generating unit back to parallel operation with mains. This automatic return usually does not happen immediately after the mains parameters are within limits, but with pre-defined time delay. For such case, the unit allows setting a time delay during which the **Fault reset (page 33)** can be automatically performed after the set time runs out.

Configuration of automatic fault reset timer by setpoint **Auto FR Del [s] (page 54)** defines a waiting time reserved for mains parameters to settle in their fault-free conditions after a **TRIP (page 32)**. This state is indicated by flashing red signal of the TRIP LED. If during this time any measured value gets out of the preset limits, MainsPro terminates the automatic fault reset count-down and goes back into fault indication state. The automatic fault reset timer is reset and started again in the moment when all measured values are back within limits again. When the automatic fault reset timer elapses, the unit performs automatic **Fault reset (page 33)** and terminates the **TRIP (page 32)** status.

9.2 Binary switches

MainsPro allows basic remote control by means of binary signals wired from an external device to MainsPro binary switches. The signals may be also provided remotely, e.g. through radio or GSM communicator devices. As an example of such a device, see the uGATE communicator below. Ask for more information about this product at support@comap-control.com.

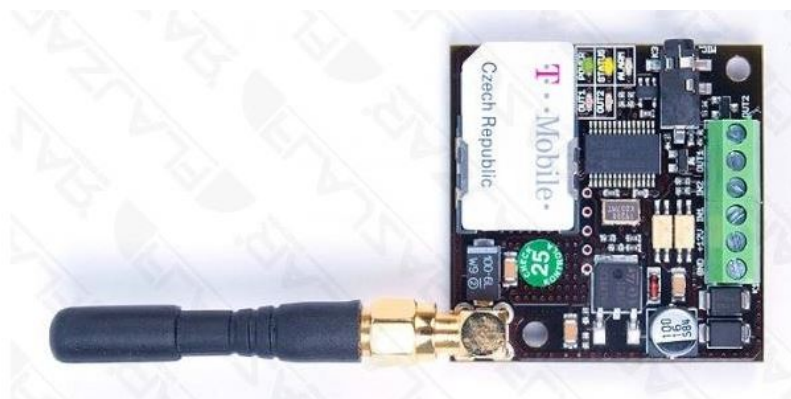

This feature enables the user to easily control the MainsPro unit functionality remotely. All four binary switches may be enabled or disabled by the appropriate setpoints in the group Basic.

9.2.1 External trip

- ▶ In case that a specific protective function is requested and this function is not supported in MainsPro, it may be provided in an external device. Wire the output of this device to **Ext1 (page 62)** or **Ext2 (page 62)** to allow tripping by this external device.
- ▶ Use the External trip also for forced disconnection of the generator if such command is for example evaluated in a superior system or transmitted through remote communication device.
- ▶ External trip functionality may be also used for intertripping method of protection system topology. This method is required by the mains operator for bigger generators.

9.2.2 Fault reset

- ▶ Use this switch in case that complex conditions are to be evaluated before the generator is allowed to be connected back to mains. These conditions may be processed in an external system and the result may be sent to this switch.
- ▶ Provided the MainsPro unit is inside a locked cabinet, an external key switch wired to this input provides a convenient way of restricting the **Fault reset (page 33)** operation to be performed by an authorized personnel only.
- ▶ Remote fault reset via GSM communicator may also be a useful feature for the remote sites.

9.2.3 Alternative settings

- ▶ **Alt Settings (page 62)** binary switch may be used in case that a specific setting of the protection relay is required by the mains operator when exceptional conditions occur. After deactivation, the unit immediately switches to the default groups of setpoints.

9.2.4 Disable

- ▶ The **Disable (page 62)** switch can be used to block the MainsPro protective functions, e.g. in case that the generator is not running in parallel operation with mains, or any other blocking conditions are fulfilled.

9.2.5 CB Feedback

- ▶ The **CB Feedback (page 62)** switch is used to confirm that a circuit breaker opened on a command issued by MainsPro. Any time some protective function is activated and a trip is issued, deactivation of this binary input is expected. If the feedback does not confirm opening of the CB, additional back-up trip **BakTrpPer (page 68)** and **BakTrpImp (page 69)** will be issued after adjustable time delay **BakTrpDel**.

9.3 Counters

Keeping a track of the most frequent trips may provide valuable information for the generator as well as distribution network operator. Use the counters indication on the **Measurement screens (page 25)** for keeping track of the most frequent failures detected in the point of your connection. For example, in case that the MainsPro counters show significantly higher rate of a certain failure types (e.g. overvoltage or Vector shift), it may be a good signal to perform a detailed evaluation of the voltage quality in the point of connection or start discussions with the DNO to allow for wider limits of the protection setting to minimize down-times of the generator.

9.4 Timer

MainsPro provides two time counters: since the unit power-up and since the last **TRIP (page 32)**. Use these timers for investigation of failures that were detected by MainsPro unit. Please note that MainsPro does not provide RTC clock and after each power-up of the unit, the time and date is lost. For this reason only indication of days / hh : mm is used. The accuracy of the time measurement has been tested and a measurement error of 4 seconds per 24 hours was observed.

9.5 Start trip

The unit supports start into the **TRIP (page 32)** state after connection of the power supply based on the setpoint **Start Trip (page 54)**. If this setpoint is set to **ENABLED**, the unit goes into the TRIP state immediately after the auxiliary power supply is turned on. If there are no failures detected it is possible to perform **Fault reset (page 33)** by any of the aforementioned means and so to put the unit into fault-free operation. If the setpoint is set to **DISABLED**, the unit goes directly into the fail-free state.

The purpose of this functionality is to allow automatic delayed return to mains in case that the mains is completely lost and MainsPro unit is powered from the same mains voltage.

9.6 TEST mode

MainsPro provides a TEST mode, which enables phase-to-phase testing of 3-phase protective features by single-phase power source.

- ▶ The test mode may be activated by entering the init screen (entered by pressing the **ENTER** and **ESC** at the same time). Follow by ← button and then ↑ button. This will open the Test mode activation screen.
- ▶ Select Y to enter the TEST mode.
- ▶ The voltage asymmetry protections are deactivated.
- ▶ The following functions are fix-assigned to the appropriate relay outputs, regardless of their actual assignment:
 - Comm Trp Per to RE3
 - f Sig to RE4
 - U Sig to RE5
- ▶ In TEST mode, the setpoint group TEST becomes visible. This group contains only one setpoint – „Phase“. Use this setpoint to assign to which input is the 1-phase measurement voltage source connected (U_A , U_B or U_C).
- ▶ All relevant protections are evaluated only in that phase, which is selected:
 - If TEST/Phase = U_a , the following protective functions are evaluated:
 - Overvoltage and undervoltage on the U_A terminals, with dual stage setting, including the Alt parameters possibility
 - Overfrequency and underfrequency on the U_A terminals, with dual stage setting, including the Alt parameters possibility
 - Loss OF Mains protections on the U_A terminals, with the Alt parameters possibility

- If TEST/Phase = Ub or Uc, the following protective functions are evaluated:
 - Overvoltage and undervoltage on the appropriate terminals, with dual stage setting, including the Alt parameters possibility

Note: *When testing on the terminals Ub and Uc, it is always necessary, that the same measurement voltage as applied on terminals Ub or Uc is also present at the terminals Ua. It is not used for testing purposes, but serves for the internal synchronization of the measurement process of the unit.*

- ▶ On the first measurement screen (homepage), the sign !!!TEST!!! is displayed in the bottom line instead of the last trip information.
- ▶ If any TRIP is performed during the TEST mode, no counters are incremented and the last trip indication and timer is not affected.
- ▶ In the TEST mode, it is possible to change setpoints, but some functionality, which is disabled in the TEST mode (e.g. voltage asymmetry setting or assignment of f(RE)) is not active.
- ▶ After return from the TEST mode, the unit goes back to its original setting including the outputs assignment and the setpoint group TEST is hidden.

To return from the TEST mode:

- ▶ Go to Test mode activation screen and select NO, or
- ▶ Turn the unit off and on again, or
- ▶ The unit goes back to the standard operation after 10 minutes from the last keyboard activity.

🔍 **back to Application tips**

10 Introduction of Reference Guide

10.1 Purpose of this manual

The Reference Guide contains library of setpoints, inputs and outputs functionalities and detailed technical information. This information is referenced in the Installation and Operation Guide and Application Guide.

11 Technical data

11.1 Accuracies and reaction times 46
 11.2 Technical parameters 47
 11.3 Factory default setting of MainsPro unit 48

 back to Table of contents

11.1 Accuracies and reaction times

11.1.1 Operating area

MainsPro provides the below mentioned accuracies and reaction times in case that the measured voltage and frequency in all 3 phases is within the green area on the picture below. Outside of the green area, MainsPro provides the expected performance (i.e. trips in case of voltage overreaching the green area border), but the behaviour, accuracies and reaction times may not be guaranteed.

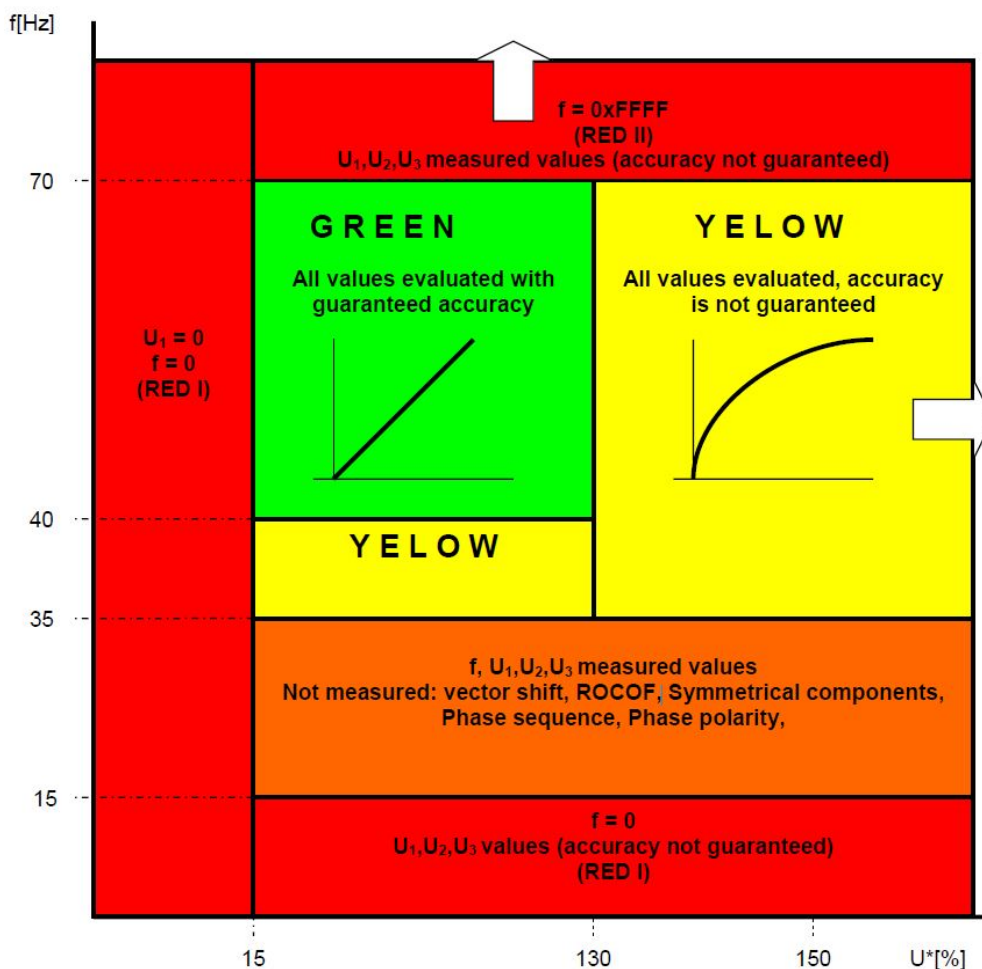

* of the range (120V or 230/400V).

Note: Please note, that in order to fulfill the requested accuracies of the unit, it is necessary that the voltage is always present at the terminals UA with the same frequency as on the other terminals. If this is not fulfilled, even if the voltages on the measurement inputs UB and UC are within green area, they will not be evaluated accurately!

11.1.2 Voltage measurement

- ▶ Voltage measurement accuracy is 1% of the nominal value at frequency 50 Hz \pm 10% and temperature 25°C.
- ▶ The accuracy is 1,5% within the complete temperature range and in the green operational area (see **Operating area on page 46**).
- ▶ Maximum reaction time for voltage failures (in case of the delay set to 0,00 s) is 2 periods of measured voltage + 15 ms. This is valid at nominal frequencies 50 Hz \pm 10% and 60 Hz \pm 10%.

11.1.3 Frequency measurement

- ▶ Frequency measurement accuracy is 0,1 Hz in the whole green operating area.
- ▶ Maximum reaction time for frequency failures (in case of the delay set to 0,00 s) is 75 ms. This is valid in the whole green operating area.

11.1.4 Time delays accuracy

- ▶ The unit allows to set the time delays with step 10 ms.
- ▶ The maximum tolerance of the unit timing is $\leq 3\% \pm 15\text{ms}$.

11.1.5 Loss of Mains reaction times

- ▶ Reaction time of Vector shift protection is 1,5 period of measured signal + 15 ms.

11.2 Technical parameters

Power supply:	8 - 40 V DC
8 - 40 V DC	Maximum consumption 600 mA Not galvanically separated from power supply 85 - 265 VAC!
85 - 265 V AC, 110 - 370 V DC	Maximum consumption 90 mA
Operating temperature range	-20°C to +70°C
Heat dissipation	13 W
Dimensions	158 x 96 x 68 mm
Protection	IP20
Rated voltage	120 V / 230 V ph-N / 400 V ph-ph
Maximal voltage range	Rated + 30%
Rated frequency of measured voltage	50 Hz, 60 Hz (indicated accuracy is guaranteed on frequency range 40-70 Hz)

Voltage measurement input impedance:	400 kΩ
Signal relay contacts:	
Max switched voltage/current	250 V / 4A
Max switched power	resistive load: 1000 VA AC, 200 W DC inductive load: 50 VA AC, 25 W DC
Rated voltage/current	resistive load: 250 V / 4 A AC 200 V / 0,1 A DC, 24 V / 4A DC inductive load: 250 V / 2 A AC 200 V / 0,1 A DC, 24 V 3A DC
Minimum load	1 W / 1VA at $U_{min} > 10 V$
Lifetime	1×10^5 cycles
Terminal tightening torque	0,4 Nm
Measurement category	III (EN 61010-1)
Appliance class	II, double insulation, the device has no protective earthing terminal (IEC 61140)
Recommended fuse of the unit power supply and measurement circuits	fuse 1A

The unit is intended for use on a DIN rail inside a switchboard with prevention of access of non-qualified personnel. In case of access of non-qualified personnel, it is necessary to cover the terminals by means corresponding to the environment of the unit operation. It is possible to make the user interface accessible to the operation staff.

11.2.1 Endurance to the power supply voltage fails

MainsPro unit withstands the power supply voltages failures of 100 ms lengths in the full range of power supply voltage on the 85 - 265 VAC / 110 - 370 VDC terminals and at the voltage 18 - 40 VDC connected to the 8 - 40 VDC terminals. The construction of the power supply allows that the unit withstands the voltage drop down to min 40 VAC in case that the unit was started from the AC voltage within the allowed range 85 - 265 VAC. A permanent voltage drop to this level does not influence the unit operation.

11.3 Factory default setting of MainsPro unit

Note: The following default setting is available from version 1.6.1. For older versions, different factory default setting was applied.

Setting	Setpoint group	Setpoint name	Value	Step	Unit
Overvoltage limit 1*)	V<>	V>	262	1	[V]
Overvoltage delay 1	V<>	V> Del	1.00	0.01	[s]
Overvoltage limit 2	V<>	V>>	273	1	[V]
Overvoltage delay 2	V<>	V>> Del	0.50	0.01	[s]
Undervoltage limit 1*)	V<>	V<	184	1	[V]
Undervoltage delay 1	V<>	V< Del	2.50	0.01	[s]

Setting	Setpoint group	Setpoint name	Value	Step	Unit
Undervoltage limit 2	V<>	V<<	0 (OFF)	1	[V]
Undervoltage delay 2	V<>	V<< Del	0.50	0.01	[s]
10 minutes floating average overvoltage*	V<>	Avg V>	0 (OFF)	1	[V]
Overvoltage hysteresis	V<>	RstV>, RstV>>	100	1	[%]
Undervoltage hysteresis	V<>	RstV<, RstV<<	100	1	[%]
Voltage asymmetry limit	dU	V unb	0.0 (OFF)	0.1	[%]
Negative sequence overvoltage limit	dU	V> neg	0.0 (OFF)	0.1	[%]
Positive sequence undervoltage limit	dU	V< pos	0.0 (OFF)	0.1	[%]
Common delay of all voltage asymmetry protections	dU	dU Del	2.50	0.01	[s]
Overfrequency limit 1	f<>	f>	0 (OFF)	0.1	[Hz]
Overfrequency delay 1	f<>	f> Del	0	0.01	[s]
Overfrequency limit 2	f<>	f>>	52.00	0.1	[Hz]
Overfrequency delay 2	f<>	f>> Del	0.50	0.01	[s]
Underfrequency limit 1	f<>	f<	47.50	0.1	[Hz]
Underfrequency delay 1	f<>	f< Del	20.00	0.01	[s]
Underfrequency limit 2	f<>	f<<	47.00	0.1	[Hz]
Underfrequency delay 2	f<>	f<< Del	0.50	0.01	[s]
Overfrequency hysteresis	f<>	Rstf>, Rstf>>	100	0.1	[%]
Underfrequency hysteresis	f<>	Rstf<, Rstf<<	100	0.1	[%]
Vector shift limit	LOM	Vs Lim	0 (OFF)	1	[°]
ROCOF limit	LOM	ROCOF	1	0.01	[Hz/s]
ROCOF filter	LOM	ROCOF Filt	9	1	[-]
ROCOF delay	LOM	ROCOF Del	0.5	0.01	[s]
Delay of Vector shift and ROCOF evaluation after measured voltage connection	LOM	LOM Init Del	3	1	[s]
Vector shift and ROCOF signalization time (TRIP duration)	LOM	LOM Trp Del	3	1	[s]
Measurement range	Basic	Uin	230	-	[V]
Measured system	Basic	System	3ph	-	-
Display timeout	Basic	DispT	0	1	[min]
Automatic Fault Reset enabling	Basic	Auto FR	ENABLED	-	-
Automatic Fault Reset timer	Basic	Auto FR Del	20	1	[s]

Setting	Setpoint group	Setpoint name	Value	Step	Unit
TRIP at the unit startup	Basic	Start Trip	DISABLED	-	-
Common impulse length	Basic	Imp Len	3	1	[s]
Back-up Trip Output Delay	Basic	Bak Trp Del	0.5	0.1	[s]
Enabling the external trip binary switch	Basic	Ext	ENABLED	-	-
Enabling the fault Reset binary switch	Basic	F.R.	DISABLED	-	-
Enabling the Alt settings binary switch	Basic	Alt	ENABLED	-	-
Enabling the blocking binary switch	Basic	Dis	DISABLED	-	-
Function of 1 st binary input	f(BI)	f(BI1)	Ext		
Function of 2 st binary input	f(BI)	f(BI2)	F.R.		
Function of 3 st binary input	f(BI)	f(BI3)	Alt		
Function of 4 st binary input	f(BI)	f(BI4)	Dis		
Function of 1 st relay output	f(RE)	f(RE1)	!CommTrpPer	-	-
Function of 2 nd relay output	f(RE)	f(RE2)	CommTrpImp	-	-
Function of 3 rd relay output	f(RE)	f(RE3)	BakTrpPer	-	-
Function of 4 th relay output	f(RE)	f(RE4)	!InternFail	-	-
Function of 5 th relay output	f(RE)	f(RE5)	TrpEndImp	-	-

Note: Please note, that the indicated setting is adjusted for "Star" connection of the measured voltage, i.e. ph-to-N voltage measurement. In case of using "Delta" connection, the appropriate change of the setpoints is necessary. Please refer to the MainsPro Installation and Operation Guide for the wiring explanation and to the MainsPro Reference Guide for information about the setpoints adjustment.

ComAp states that the mentioned setting is guaranteed for all MainsPro units, SW version 1.5, upon shipment of a new unit, if no other setting is explicitly requested. In case of need, the factory default settings can be obtained by the following procedure:

1. Enter the init screen by pushing the **ENTER** and **ESC** at the same time.
2. Press ← and ↓ to enter the Factory default activation screen:

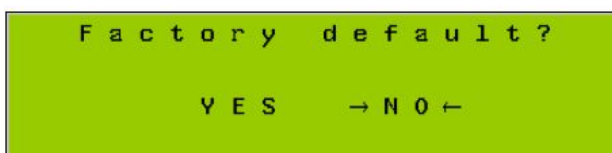

3. Press ← and then use the buttons ↑ and ↓ to choose the required function. By selecting YES, you will return all previously done setting to the default values. **Please note that by this selection, you will lose all setting done prior to this operation!** Press **ENTER** to confirm your selection.
4. By selecting NO and pressing **ENTER** or by pressing **ESC**, return to the measurement screens with no change.

🔍 back to Technical data

12 Appendix

12.1 Library of Setpoints 52
12.2 Library of Binary switches 62
12.3 Relay outputs 63

 [back to Table of contents](#)

12.1 Library of Setpoints

MainsPro provides the possibility of dual setting of the protection functions setpoints. This setting may be used in case that the installation is running in exceptional conditions with different requirements for protections setting. Some groups of setpoints have their alternative setpoints identified by the same name, but with letter “A.” at the beginning (e.g. V<>, A.V<> etc.). By activating the binary switch Alt settings, the unit is immediately switched to the setting, done in the “A.xx” group, **see Library of Binary switches on page 62.**

Uin	53
System	53
DispT [min]	53
Auto FR	53
Auto FR Del [s]	54
Start Trip	54
Imp Len [s]	54
Bak Trp Del [s]	54
Ext	55
F.R.	55
Alt	55
Disable	55
V>, V>>, V<, V<<, A.V>, A.V>>, A.V<, A.V<< [V]	56
V> del, V>> del, V< del, V<< del [s]	56
Avg V> [V]	56
RstV>,V>> [%V>]	57
RstV<,V<< [%V<]	57
V unb, A.V unb [V]	57
V< pos, A.V< pos [V]	57
V> neg, A.V> neg [V]	58
dU del, A.dU del [s]	58
f>, f>>, f<, f<<, A.f>, A.f>>, A.f<, A.f<< [Hz]	58
f> del, f>> del, f< del, f<< del, A.f> del, A.f>> del, A.f< del, A.f<< del [s]	58
Rstf>,f>> [%f>]	59
Rstf<,f<< [%f<]	59
VS lim, A.VS lim [°]	59
ROCOF, A.ROCOF [Hz/s]	59
ROCOF filt, A.ROCOF filt [-]	60
LOM Init Del, A. LOM Init Del [s]	60
LOM Trp Del, A.LOM Trp Del [s]	60
ROCOF Del/A.ROCOF Del [s]	60
f(RE1-5)	61

 **back to Appendix**

12.1.1 Group: Basic

Uin

Selection of the measurement range to adjust the HW for maximum accuracy.

230 V	the unit measures 230 VAC phase-neutral with max over-range 130% (300 VAC)
400 V	the unit measures 400 V phase-phase with max over-range 130% (520 VAC)
120 V	the unit measures 120 VAC phase-neutral or on the secondary winding of the VT with max over-range 130% (156 VAC)
Default setting	230 V

[back to Library of Setpoints](#)

System

Selection of single phase or three-phase application. In case of single phase setting, the voltage on last two phases and voltage asymmetry are not measured.

3ph	the unit measures 3-phase system
1ph	the unit measures single-phase system
Default setting	3ph

[back to Library of Setpoints](#)

DispT [min]

Setting of display backlight timeout since the last button activity.

Range	1..60 min
0 min	= OFF, display is set to permanent backlight
Default setting	0 min

[back to Library of Setpoints](#)

Auto FR

Enables or disables the functionality of the automatic fault reset by internal timer.

ENABLED	the functionality is enabled
DISABLED	the functionality is disabled
Default setting	ENABLED

[back to Library of Setpoints](#)

Auto FR Del [s]

Automatic fault reset delay. The timer starts to count in the moment when TRIP is detected, but the fault conditions are cleared. After the Auto FR del time, the Fault reset is done automatically to allow automatic reconnection.

Range	0..6000 s
Default setting	20 s

[◀ back to Library of Setpoints](#)

Start Trip

Start of the unit into the TRIP state to allow automatic delayed return to mains in case that the mains is completely lost and MainsPro unit is powered from the same mains voltage.

ENABLED	after power-up, the unit goes immediately into the TRIP state and only after successful fault reset its outputs are set to the fault-free state.
DISABLED	after power-up, all values are evaluated on the measurement inputs and depending on the measured values, the unit goes either into fault-free or TRIP state.
Default setting	DISABLED

[◀ back to Library of Setpoints](#)

Imp Len [s]

Impulse length in case of activation of various impulse outputs of the protection. The setpoint is referenced in the appropriate outputs description.

Range	0..60 s
Default setting	3 s

[◀ back to Library of Setpoints](#)

Bak Trp Del [s]

Adjustable time period during which the BI CB Feedback is expected to deactivate. If the input does not deactivate within this time, immediate backup trip BakTrpPer or BackTrpImp is issued to open the backup circuit breaker.

Range	0.0..10.0 s
Default setting	0.5 s

[◀ back to Library of Setpoints](#)

Ext

Enables or disables the functionality of the External trip.

ENABLED	external trip is enabled and binary input with Ext1 (page 62) or Ext2 (page 62) function can be used to induce external trip
DISABLED	external trip is disabled
Default setting	ENABLED

[◀ back to Library of Setpoints](#)

F.R.

Enables or disables the functionality of the Fault reset binary switch and the button Fault reset.

ENABLED	the binary switch and the button is enabled for fault reset
DISABLED	the binary switch and the button is disabled for fault reset
Default setting	DISABLED

[◀ back to Library of Setpoints](#)

Alt

Enables or disables the functionality of the Alternative settings binary switch.

ENABLED	the binary switch is enabled
DISABLED	the binary switch is disabled
Default setting	ENABLED

[◀ back to Library of Setpoints](#)

Disable

Enables or disables the functionality of the Disable binary switch.

ENABLED	the binary switch is enabled
ENABLEDexITRP	the binary switch is enabled only in case the unit is not in TRIP state. If the fault was not reset after its detection, activation of the BI Disable will have no influence on the unit operation until fault reset is performed
DISABLED	the binary switch is disabled
Default setting	DISABLED

[◀ back to Library of Setpoints](#)

12.1.2 Group: V <>, A.V <>

V>, V>>, V<, V<<, A.V>, A.V>>, A.V<, A.V<< [V]

Threshold of 1st and 2nd stage overvoltage, and 1st and 2nd stage undervoltage protection, respectively.

Range	1..999 V	
0	= OFF, the appropriate stage of voltage protection is not enabled	
Default setting	V>	262 V
	V>>	273 V
	V<	184 V
	V<<	0 V

Note: Please note, that the indicated setting is adjusted for "Star" connection of the measured voltage, i.e. ph-to-N voltage measurement. In case of using "Delta" connection, the appropriate change of the setpoints to ph-ph voltage is necessary.

[back to Library of Setpoints](#)

V> del, V>> del, V< del, V<< del [s]

Delay of the appropriate stage of the voltage protection.

Range	0.00..600.00 s	
Default setting	V> Del	1.00 s
	V>> Del	0.50 s
	V< Del	2.50 s
	V<< Del	0.50 s

[back to Library of Setpoints](#)

Avg V> [V]

Limit for Floating 10 minutes average overvoltage (page 35) protection.

Range	0..34000 V	
0	= OFF, the 10 minutes average overvoltage protection is not enabled	
Default setting	0 (OFF)	

[back to Library of Setpoints](#)

RstV>,V>> [%V>]

Voltage level at which the protection activates again after a trip caused by overvoltage. The TRIP status will be terminated. The setpoint is set in percentage of overvoltage threshold. In case the nominal voltage is 230 V and the overvoltage threshold is 250 V, the hysteresis limit for default setting 96 %V> is 240 V. It means that voltage must drop under 240 V to reset the fault.

Range	90 - 100 %V>
0	= OFF, the reset threshold is not activated
Default setting	100 %V>

[back to Library of Setpoints](#)

RstV<,V<< [%V<]

Voltage level at which the protection activates again after a trip caused by undervoltage. The TRIP status will be terminated. The setpoint is set in percentage of undervoltage threshold. In case the nominal voltage is 230 V and the undervoltage threshold is 200 V, the hysteresis limit for default setting 104 %V> is 208 V. It means that voltage must get over 208 V to reset the fault.

Range	100 - 110 %V<
0	= OFF, the reset threshold is not activated
Default setting	100 %V<

[back to Library of Setpoints](#)

12.1.3 Group: dU, A.dU

V unb, A.V unb [V]

Threshold of the voltage unbalance (amplitude asymmetry). The value corresponds with the maximum difference between highest and lowest RMS phase voltage of the 3-phase system.

Range	0.0..100.0 %Un
0	= OFF, the amplitude asymmetry is disabled
Default setting	0.0 %Un = OFF

[back to Library of Setpoints](#)

V< pos, A.V< pos [V]

Threshold of the positive sequence undervoltage (angle asymmetry method).

Range	0.0..100.0 %Un
0	= OFF, the positive sequence undervoltage is disabled
Default setting	0.0 %Un = OFF

[back to Library of Setpoints](#)

V> neg, A.V> neg [V]

Threshold of the negative sequence overvoltage (angle asymmetry method).

Range	0.0..100.0 %Un
0	= OFF, the negative sequence overvoltage is disabled
Default setting	0.0 %Un = OFF

[back to Library of Setpoints](#)

dU del, A.dU del [s]

Delay of the voltage unbalance (amplitude asymmetry) protection.

Range	0.00..600.00 s
Default setting	2.5 s

[back to Library of Setpoints](#)

12.1.4 Group: f <>, A.f <>

f>, f>>, f<, f<<, A.f>, A.f>>, A.f<, A.f<< [Hz]

Threshold of 1st and 2nd stage overfrequency and 1st and 2nd stage underfrequency protection, respectively.

Range	45.00..65.00 Hz								
0	= OFF, the appropriate stage of frequency protection is not enabled								
Default setting	<table> <tr> <td>f></td> <td>0 Hz</td> </tr> <tr> <td>f>></td> <td>52.00 Hz</td> </tr> <tr> <td>f<</td> <td>47.50 Hz</td> </tr> <tr> <td>f<<</td> <td>47.00 Hz</td> </tr> </table>	f>	0 Hz	f>>	52.00 Hz	f<	47.50 Hz	f<<	47.00 Hz
f>	0 Hz								
f>>	52.00 Hz								
f<	47.50 Hz								
f<<	47.00 Hz								

[back to Library of Setpoints](#)

f> del, f>> del, f< del, f<< del, A.f> del, A.f>> del, A.f< del, A.f<< del [s]

Delay of the appropriate stage of the frequency protection.

Range	0.00..600.00 s								
Default setting	<table> <tr> <td>f> Del</td> <td>0 s</td> </tr> <tr> <td>f>> Del</td> <td>0.50 s</td> </tr> <tr> <td>f< Del</td> <td>20.0 s</td> </tr> <tr> <td>f<< Del</td> <td>0.50 s</td> </tr> </table>	f> Del	0 s	f>> Del	0.50 s	f< Del	20.0 s	f<< Del	0.50 s
f> Del	0 s								
f>> Del	0.50 s								
f< Del	20.0 s								
f<< Del	0.50 s								

[back to Library of Setpoints](#)

Rstf>,f>> [%f>]

Frequency level at which the protection activates again after a trip caused by overfrequency. The TRIP status will be terminated.

Range	90.0 - 100.0 %f>
0	= OFF, the reset threshold is not activated
Default setting	100.0 %f>

[back to Library of Setpoints](#)

Rstf<,f<< [%f<]

Frequency level at which the protection activates again after a trip caused by underfrequency. The TRIP status will be terminated.

Range	100.0 - 110.0 %f<
0	= OFF, the reset threshold is not activated
Default setting	100.0 %f<

[back to Library of Setpoints](#)

12.1.5 Group: LOM, A.LOM

VS lim, A.VS lim [°]

Threshold at which the Vector shift protection is activated.

Range	1..50°
0	= OFF, the Vector shift protection is not enabled
Default setting	0°

[back to Library of Setpoints](#)

ROCOF, A.ROCOF [Hz/s]

Threshold at which the Rate of change of frequency (ROCOF) protection is activated.

Range	0.01..10.00 Hz/s
0	= OFF, the ROCOF protection is not enabled
Default setting	1

[back to Library of Setpoints](#)

ROCOF filt, A.ROCOF filt [-]

Number of periods considered for evaluating ROCOF protection. Higher number means lower sensitivity and longer evaluation time. Lower number means increased sensitivity and shorter evaluation time.

Range	1 .. 100
Default setting	9 [-]

[◀ back to Library of Setpoints](#)

LOM Init Del, A. LOM Init Del [s]

Delay for which the Loss of Mains (LOM, i.e. Vector shift and ROCOF) protection is disabled after sensing a valid voltage on measurement terminals (stepping into the operational area of voltage and frequency).

Range	0..600 s
Default setting	3 s

[◀ back to Library of Setpoints](#)

LOM Trp Del, A.LOM Trp Del [s]

Duration of Loss of Mains (LOM, i.e. Vector shift and ROCOF) protection trip. After this delay, the fault is considered as terminated and Fault reset is possible. In case of automatic fault reset, the timer is started.

Range	0..3600 s
Default setting	3 s

[◀ back to Library of Setpoints](#)

ROCOF Del/A.ROCOF Del [s]

When ROCOF value is above the ROCOF threshold, trip is delayed based on ROCOF Del setting. ROCOF protection trips only in case that ROCOF value is above the ROCOF threshold for the ROCOF Del time. Use the default ROCOF Del setting to 0,00 s in case that ROCOF protection should trip immediately as soon as ROCOF value above the ROCOF threshold is detected.

Range	0..10 s
Default setting	0.5 s

[◀ back to Library of Setpoints](#)

12.1.6 Group: f(BI)

Function assigned to the appropriate binary input. For description, see **Library of Binary switches on page 62**.

<ul style="list-style-type: none"> ▶ Ext1 ▶ Ext2 ▶ F.R. ▶ Alt ▶ Dis ▶ CB Fdb ▶ Not used (for the possibility if none of the defined BI is assigned) 									
Default setting	<table border="0"> <tr><td>BI1</td><td>Ext1</td></tr> <tr><td>BI2</td><td>F.R.</td></tr> <tr><td>BI3</td><td>Alt</td></tr> <tr><td>BI4</td><td>Dis</td></tr> </table>	BI1	Ext1	BI2	F.R.	BI3	Alt	BI4	Dis
BI1	Ext1								
BI2	F.R.								
BI3	Alt								
BI4	Dis								

12.1.7 Group: f(RE)

f(RE1-5)

Function assigned to the appropriate relay output 1 to 5. For description, **see Relay outputs on page 63.**

CommTrpPer	LOM Sig										
!CommTrpPer	!LOM Sig										
CommTrpImp	dU Sig										
!CommTrpImp	!dU Sig										
CommSigImp	Other Sig										
!CommSigImp	!Other Sig										
CommSigDel	Alt sig										
!CommSigDel	TrpEndImp										
U Sig	InternFail										
!U Sig	BakTrpPer										
f Sig	BakTrpImp										
!f Sig											
Default setting	<table border="0"> <tr><td>RE1</td><td>!CommTrpPer</td></tr> <tr><td>RE2</td><td>CommTrpImp</td></tr> <tr><td>RE3</td><td>BakTrpPer</td></tr> <tr><td>RE4</td><td>!InternFail</td></tr> <tr><td>RE5</td><td>TrpEndImp</td></tr> </table>	RE1	!CommTrpPer	RE2	CommTrpImp	RE3	BakTrpPer	RE4	!InternFail	RE5	TrpEndImp
RE1	!CommTrpPer										
RE2	CommTrpImp										
RE3	BakTrpPer										
RE4	!InternFail										
RE5	TrpEndImp										

 [back to Library of Setpoints](#)

12.2 Library of Binary switches

12.2.1 Ext1	62
12.2.2 Ext2	62
12.2.3 Fault Reset	62
12.2.4 Alt Settings	62
12.2.5 Disable	62
12.2.6 CB Feedback	62

 [back to Appendix](#)

12.2.1 Ext1

Activation of this input causes immediate trip of the protection. The trip conditions are active throughout the activation of this input.

12.2.2 Ext2

Activation of this input causes immediate trip of the protection. The trip conditions are active throughout the activation of this input.

12.2.3 Fault Reset

Activation of this switch causes fault reset. The input has the same effect as pushing the button FltRes. If permanently activated, every 100ms an impulse to fault reset the unit is done internally.

12.2.4 Alt Settings

Activation of this switch causes immediate switching to the alternative setting as per the setpoint groups marked as „A.xx”. In case that the switchover comes in the moment when a delay of some of the protection stage is being count-down (the unit is about to trip), the timer setting is kept as before the switch. However, if the trip conditions change during the delay run (e.g. by changing the protection threshold), the trip is not performed.

12.2.5 Disable

Activation of this switch disables immediately all protective features of the unit. The switch may be used e.g. in case that the generator is not yet in parallel-to-mains operation, and so the mains parameters do not have to be evaluated. In this case, the unit does not trip on any fault condition.

12.2.6 CB Feedback

Deactivation of this switch confirms opening of the circuit breaker after a trip is issued by MainsPro. If the feedback does not confirm opening of the CB, an additional back-up trip BakTrpPer or BakTrpImp will be issued after adjustable time delay BakTrp Del.

 [back to Library of Binary switches](#)

12.3 Relay outputs

The standard functionality of MainsPro corresponds with the standard of protective relays and offers an option to set the logic of the relay outputs. For safety reasons, all outputs are available in an Normally Closed (NC) version. Those are indicated by an exclamation mark (!) and remain energized in a fault-free state and in case of power supply failure the output relay deactivates. MainsPro also allows setting the output relays to Normally Open (NO), so the outputs maintain de-energized in fault-free state and in case of a trip, the relays energize.

12.3.1 CommTrpPer	64
12.3.2 !CommTrpPer	64
12.3.3 CommTrpImp	64
12.3.4 !CommTrpImp	64
12.3.5 CommSigImp	64
12.3.6 !CommSigImp	65
12.3.7 CommSigDel	65
12.3.8 !CommSigDel	65
12.3.9 U Sig	65
12.3.10 !U Sig	65
12.3.11 f Sig	66
12.3.12 !f Sig	66
12.3.13 LOM Sig	66
12.3.14 !LOM Sig	66
12.3.15 dU Sig	66
12.3.16 !dU Sig	67
12.3.17 Other Sig	67
12.3.18 !Other Sig	67
12.3.19 Alt Sig	67
12.3.20 TrpEndImp	67
12.3.21 !TrpEndImp	68
12.3.22 InternFail	68
12.3.23 !InternFail	68
12.3.24 BakTrpPer	68
12.3.25 !BakTrpPer	68
12.3.26 BakTrpImp	69
12.3.27 !BakTrpImp	69

 [back to Appendix](#)

12.3.1 CommTrpPer

Common trip permanent relay; closes at any failure with a delay given by appropriate parameter. The relay is kept in open position in a fault-free state and closes immediately in case of LOM protection (Vector shift or ROCOF), External trip, incorrect phase rotation or wrong phase polarity. Relay opens in fault free state after successful fault reset. In case of LOM protection, the delay **LOM Trp Del**, **A.LOM Trp Del [s]** (page 60) is timed out and after this time it is possible to perform **Fault reset** (page 33).

[🔍 back to Relay outputs](#)

12.3.2 !CommTrpPer

Inverse common trip permanent relay; opens at any failure with a delay given by appropriate parameter. The relay opens immediately in case of LOM protection (Vector shift or ROCOF), External trip, incorrect phase rotation or wrong phase polarity. Relay closes in fault free state after a successful fault reset. In case of LOM protection, the delay **LOM Trp Del**, **A.LOM Trp Del [s]** (page 60) is timed out and after this time it is possible to perform Fault reset.

[🔍 back to Relay outputs](#)

12.3.3 CommTrpImp

Common trip impulse relay; closes at any failure with a delay given by appropriate parameter. The relay is kept in open position in a fault-free state and closes immediately in case of LOM protection (Vector shift or ROCOF), External trip, incorrect phase rotation or wrong phase polarity. Relay opens after **Imp Len [s]** (page 54) has timed out, his opening however does not mean end of trip state! Trip is terminated in fault free state after a successful fault reset. In case of LOM protection, the delay **LOM Trp Del**, **A.LOM Trp Del [s]** (page 60) is timed out and after this time it is possible to perform Fault reset. During trip status, the relay does not react on any new failure.

[🔍 back to Relay outputs](#)

12.3.4 !CommTrpImp

Inverse common trip impulse relay; opens at any failure with a delay given by appropriate parameter. The relay opens immediately in case of LOM protection (Vector shift or ROCOF), External trip, incorrect phase rotation or wrong phase polarity. Relay closes after Basic: Imp Len has timed out, his closing however does not mean end of trip state! Trip is terminated in fault free state after a successful fault reset. In case of LOM protection, the delay **LOM Trp Del**, **A.LOM Trp Del [s]** (page 60) is timed out and after this time it is possible to perform Fault reset. During trip status, the relay does not react on any new failure.

[🔍 back to Relay outputs](#)

12.3.5 CommSigImp

Immediate impulse signaling relay; closes immediately at any failure. The relay opens after **Imp Len [s]** (page 54) since its closing. Any other detected fault-state during run of this timer has no effect. Fault reset has no influence on this output.

[🔍 back to Relay outputs](#)

12.3.6 !CommSigImp

Inverse immediate impulse signaling relay; opens immediately at any failure. The relay closes after **Imp Len [s]** (page 54) since its opening. Any other detected fault-state during run of this timer has no effect. Fault reset has no influence on this output.

[◀ back to Relay outputs](#)

12.3.7 CommSigDel

Impulse signaling relay delayed; closes at any failure with a delay given by appropriate parameter. The relay closes immediately in case of LOM protection (Vector shift or ROCOF), External trip, incorrect phase rotation or wrong phase polarity. Relay opens after **Imp Len [s]** (page 54) since its closing. Any other detected fault-state during run of this timer causes a new activation of this relay or extends timing of **Imp Len [s]** (page 54) by the new impulse length from the moment of the failure detection. Fault reset has no influence on this output.

[◀ back to Relay outputs](#)

12.3.8 !CommSigDel

Inverse impulse signaling relay delayed; opens at any failure with a delay given by appropriate parameter. The relay opens immediately in case of LOM protection (Vector shift or ROCOF), External trip, incorrect phase rotation or wrong phase polarity. Relay closes after **Imp Len [s]** (page 54) since its opening. Any other detected fault-state during run of this timer causes a new activation of this relay or extends timing of **Imp Len [s]** (page 54) by the new impulse length from the moment of the failure detection. Fault reset has no influence on this output.

[◀ back to Relay outputs](#)

12.3.9 U Sig

Immediate signaling relay – voltage; closes immediately in case of voltage failure (over, under voltage or average overvoltage). The relay opens in case that all parameters are back within limits, but no sooner than after Basic: Imp Len from its activation. If the relay is closed during trip activation, it opens no sooner than **Imp Len [s]** (page 54) since trip status activation. Fault reset has no influence on this output. If any voltage protection is disabled by setpoint (limit set to 0), the output does not signal activation of this protection stage.

[◀ back to Relay outputs](#)

12.3.10 !U Sig

Inverse immediate signaling relay – voltage; opens immediately in case of voltage failure (over, under voltage or average overvoltage). The relay closes in case that all parameters are back within limits, but no sooner than after **Imp Len [s]** (page 54) from its activation. If the relay is open during trip activation, it closes no sooner than Basic: Imp Len since trip status activation. Fault reset has no influence on this output. If any voltage protection is disabled by setpoint (limit set to 0), the output does not signal activation of this protection stage.

[◀ back to Relay outputs](#)

12.3.11 f Sig

Immediate signaling relay – frequency; closes immediately in case of frequency failure (over or under frequency). The relay opens in case that all parameters are back within limits, but no sooner than after **Basic: Imp Len** from its activation. If the relay is closed during trip activation, it opens no sooner than **Imp Len [s]** (page 54) since trip status activation. Fault reset has no influence on this output. If any frequency protection is disabled by setpoint (limit set to 0), the output does not signal activation of this protection stage.

🔍 back to Relay outputs

12.3.12 !f Sig

Inverse immediate signaling relay – frequency; opens immediately in case of frequency failure (over or under frequency). The relay closes in case that all parameters are back within limits, but no sooner than after **Imp Len [s]** (page 54) from its activation. If the relay is open during trip activation, it closes no sooner than **Basic: Imp Len** since trip status activation. Fault reset has no influence on this output. If any frequency protection is disabled by setpoint (limit set to 0), the output does not signal activation of this protection stage.

🔍 back to Relay outputs

12.3.13 LOM Sig

Immediate signaling relay – loss of mains; closes immediately in case of loss of mains failure (Vector shift or ROCOF). The relay opens after **LOM Trp Del, A.LOM Trp Del [s]** (page 60) since the last LOM protection activation. Fault reset has no influence on this output. If any LOM protection is disabled by setpoint (limit set to 0), the output does not signal activation of this protection stage.

🔍 back to Relay outputs

12.3.14 !LOM Sig

Inverse immediate signaling relay – loss of mains; opens immediately in case of loss of mains failure (Vector shift or ROCOF). The relay closes after **LOM Trp Del, A.LOM Trp Del [s]** (page 60) since the last LOM protection activation. Fault reset has no influence on this output. If any LOM protection is disabled by setpoint (limit set to 0), the output does not signal activation of this protection stage.

🔍 back to Relay outputs

12.3.15 dU Sig

Immediate signaling relay – asymmetry; closes immediately in case of voltage (amplitude) unbalance, positive sequence undervoltage, negative sequence overvoltage, or failure (over or under frequency). The relay opens in case that all three evaluation methods of voltage asymmetry are in fail-free state, but no sooner than after **Imp Len [s]** (page 54) from its activation. If the relay is closed during trip activation, it opens no sooner than **Basic: Imp Len** since trip status activation. Fault reset has no influence on this output. If any asymmetry protection is disabled by setpoint (limit set to 0), the output does not signal activation of this protection stage.

🔍 back to Relay outputs

12.3.16 !dU Sig

Inverse immediate signaling relay – asymmetry; opens immediately in case of voltage (amplitude) unbalance, positive sequence undervoltage, negative sequence overvoltage, or failure (over or under frequency). The relay closes in case that all three methods of voltage asymmetry are in fail-free state, but no sooner than after **Imp Len [s]** (page 54) from its activation. If the relay is open during trip activation, it closes no sooner than Basic: Imp Len since trip status activation. Fault reset has no influence on this output. If any asymmetry protection is disabled by setpoint (limit set to 0), the output does not signal activation of this protection stage.

 [back to Relay outputs](#)

12.3.17 Other Sig

Immediate signaling relay – other failures; closes immediately in case of incorrect phase rotation, wrong polarity of one phase or External trip. The relay opens in case that all observed failures are not active, but no sooner than after **Imp Len [s]** (page 54) from its activation. If the relay is closed during trip activation, it opens no sooner than Basic: Imp Len since trip status activation. Fault reset has no influence on this output.

 [back to Relay outputs](#)

12.3.18 !Other Sig

Inverse immediate signaling relay – other failures; opens immediately in case of incorrect phase rotation, wrong polarity of one phase or External trip. The relay closes in case that all observed failures are not active, but no sooner than after **Imp Len [s]** (page 54) from its activation. If the relay is open during trip activation, it closes no sooner than Basic: Imp Len since trip status activation. Fault reset has no influence on this output.

 [back to Relay outputs](#)

12.3.19 Alt Sig

This output signals activation of binary input Alt Setting. This output is activated as long as alternative setting is active and Alt setting is enabled.

 [back to Relay outputs](#)

12.3.20 TrpEndImp

Impulse at the end of the TRIP state. The output is normally activated during operation of the unit. The output deactivates at the end of the TRIP (page 32) (i.e. after successful Fault reset (page 33) is performed) for period given by the parameter **Imp Len [s]** (page 54).

In case of subsequent trip in the moment of the output deactivation, the countdown of the Imp Len delay is not interrupted and the output stays deactivated for the complete Imp Len period. If in that period the TRIP state is terminated again, the deactivation period is prolonged to Imp Len from the latest Fault Reset. If during TRIP state the unit is disabled by the input **Disable** (page 62), the output TrpEndImp is deactivated, same as in case of a successful Fault reset.

The output can generally be used for closing the circuit breaker by the ON coil.

 [back to Relay outputs](#)

12.3.21 !TrpEndImp

Inverse impulse at the end of the TRIP state. The output is normally deactivated during operation of the unit. The output activates at the end of the **TRIP (page 32)** (i.e. after successful **Fault reset (page 33)** is performed) for period given by the parameter **Imp Len [s] (page 54)**.

In case of subsequent trip in the moment of the output activation, the countdown of the Imp Len delay is not interrupted and the output stays activated for the complete Imp Len period. If in that period the TRIP state is terminated again, the activation period is prolonged to Imp Len from the latest **Fault reset (page 33)**. If during TRIP state the unit is disabled by the input **Disable (page 62)**, the output TrpEndImp is activated, same as in case of a successful Fault reset.

The output can generally be used for closing the circuit breaker by the ON coil.

 [back to Relay outputs](#)

12.3.22 InternFail

Immediate signaling relay – internal failures; closes immediately in case of internal software failure, including watchdog activation. The relay opens in case that all observed failures are not active, but no sooner than after **Imp Len [s] (page 54)** from its activation. If the relay is closed during trip activation, it opens no sooner than Basic: Imp Len time is up. Fault reset, performed either by pressing the Fault reset button or through binary input, has no influence on this output.

 [back to Relay outputs](#)

12.3.23 !InternFail

Inverse immediate signaling relay – internal failures; opens immediately in case of internal software failure, including watchdog activation. The relay closes in case that all observed failures are not active, but no sooner than after **Imp Len [s] (page 54)** from its activation. If the relay is open during trip activation, it closes no sooner than Basic: Imp Len time is up. Fault reset, performed either by pressing the Fault reset button or through binary input, has no influence on this output.

 [back to Relay outputs](#)

12.3.24 BakTrpPer

Backup trip permanent relay; closes if any of the **CommTrpPer (page 64)** or **CommTrpImp (page 64)** is activated and CB Feedback doesn't deactivate within Bak Trp Del. Resets by successful fault reset or if the CB Feedback deactivates before the countdown stops.

If the CB Feedback input or Bak Trp output are not configured on any physical input or output, this function is blocked.

 [back to Relay outputs](#)

12.3.25 !BakTrpPer

Inverse backup trip permanent relay; opens if any of the **CommTrpPer (page 64)** or **CommTrpImp (page 64)** is activated and CB Feedback doesn't deactivate within BakTrpPer (page 1). Resets by successful fault reset or if the CB Feedback deactivates before the countdown stops.

If the CB Feedback input or Bak Trp output are not configured on any physical input or output, this function is blocked.

 [back to Relay outputs](#)

12.3.26 BakTrpImp

Backup trip impulse relay; closes immediately if any of the **CommTrpPer (page 64)** or **CommTrpImp (page 64)** is activated and CB Feedback doesn't deactivate within Bak Trp Del. The length of the impulse can be adjusted in **Imp Len [s] (page 54)**. Opening of the relay does not mean end of trip state. The trip is terminated in fault free state after a successful fault reset. During trip status, the relay does not react on any new failure and also, if the CB Feedback input or Bak Trp output are not configured on any physical input or output, this function is blocked.

[🔍 back to Relay outputs](#)

12.3.27 !BakTrpImp

Inverse backup trip impulse relay; opens immediately if any of the **CommTrpPer (page 64)** or **CommTrpImp (page 64)** is activated and CB Feedback doesn't deactivate within Bak Trp Del. The length of the impulse can be adjusted in **Imp Len [s] (page 54)**. Closing of the relay does not mean end of trip state. The trip is terminated in fault free state after a successful fault reset. During trip status, the relay does not react on any new failure and also, if the CB Feedback input or Bak Trp output are not configured on any physical input or output, this function is blocked.

[🔍 back to Relay outputs](#)

[🔍 back to Appendix](#)